

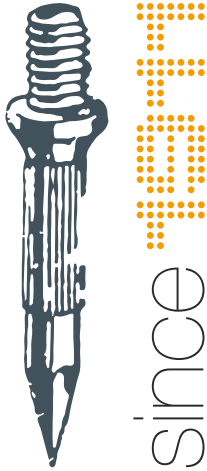

Guide to cable support systems

System selection, mounting conditions, standards



Many years of experience

OBO BETTERMANN has offered products and solutions for electrical installation for over 100 years. Our focus has always been on solutions from the field of cable support systems. With our many years of experience, we are one of the leading manufacturers in this field.

Establishing partnerships with customers is a top priority for OBO, and OBO staff are available to support customers in all aspects of their projects, including products, installation and planning advice. This is because we not only supply our customers with products and solutions, which intermesh and represent an unbeatable system for industrial installations, but also stand by their side as a competent partner, offering expert knowledge.

The spirit of innovation as a company policy

At OBO, the spirit of innovation is simply part of everyday life – so much so that it's even a part of our name. Our name originates from the OBO anchor: Until 1952, there was no way around it – anyone wanting to put an anchor into the wall had to drill a hole. However, OBO engineers were not satisfied with this and developed a metal anchor, which could simply be knocked into the wall. A true innovation for those times. OBO – ohne Bohren (without drilling) – became a part of our name.

More than half a century has passed since this invention. However, OBO's spirit of innovation has remained and continues to flow into now more than 30,000 products.



Cable support systems from OBO

Our products for your project

When developing our cable support systems, three attributes are at the core of what we do: efficiency, resilience and safety.

Our cable support systems are part of the Industrial installations area of application and, for all products used in industry, the following applies: They must withstand different weather and

ambient conditions, as well as mechanical loads.

OBO can offer reliable solutions for routing and fastening cables securely for each of these installation challenges in the industrial environment.

Guide to cable support systems

Characteristics of cable support systems	4
Terminology	5
Corrosion and corrosion protection	6
Surfaces	7
Materials	10
Corrosivity categories according to DIN EN ISO 12944-2:2018	11
Typical environments and recommended surfaces/materials	12
System selection	14
Mounting systems	15
Cable tray systems	15
Mesh cable tray systems	15
Cable ladder systems	15
System application	15
Selection of the correct system	16
Mounting conditions	24
Tightening torques for bolts	25
Tightening torques for steel bolts with metric thread	25
Tightening torques for stainless steel bolts with metric thread	25
Load values, product standard IEC 61537:2006	26
Terms	27
General requirements	27
Labelling and documentation	27
Classification	28
Mechanical load testing to determine the safe working load (SWL)	29
Safe installation of supports with brackets	32
Declarations	34
Certifications	35
VDE symbol approval	35
UL certificate	35
Underwriters Laboratories (UL) and Canadian Standards Association (CSA Group)	36
EPD Environmental Product Declaration	36
Maintenance of electrical function for safety-relevant electrical systems	37
Cable systems with integrated maintenance of electrical function	37
DIN 4102 Part 12: Contents and requirements	37
VDE 0100 Earthing: Definition, legal and standard requirements	37
International standardisation	38
EC declarations of conformity	39
EMC shield attenuation	40
General information	41
Magnetic shield insulation	42
Summary	43
Our support for your project	44
OBO Academy – from basic principles to the concrete application	45
OBO Construct – planning software and product configurators	46
OBO Customer Service	47

1. Characteristics of cable support systems

1.1 Terminology	5
1.2 Corrosion and corrosion protection	6
1.3 Surfaces	7
1.4 Materials	10
1.5 Corrosiveness categories according to DIN EN ISO 12944-2:2018	11
1.6 Typical environments and recommended surfaces/materials	12

1.1 Terminology

To create a shared basis, a **term definition** is normally introduced. This is important in order to understand the standard correctly at the following points in the text. The most important terms will be explained briefly.

According to DIN EN 61537, a **cable support system** is used to support and house cables. The system allows the use of electrical resources in electrical installations and/or in communication systems. In addition, a cable support system can be used to separate and arrange cables in groups. The systems are installed on ceilings, walls or floors.

The **material** of a cable support system is normally steel or stainless steel. Various galvanisation surfaces can be applied to improve corrosion protection.

A **cable support system** consists of cable support lengths and system components, such as cable support fittings, support elements, mounting elements and system accessories. The cable support lengths and fittings can basically be designed as cable trays, cable ladders or mesh cable trays, in which cables are routed.

Fittings can, on the one hand, be used for horizontal or vertical changing of the routing direction or, on the other, to change the height or width of the dimension. Practical examples for this are horizontal or vertical bends, T pieces, cross-overs, reductions or also end closures.

By contrast, a **support element** is constructed to support the previously described cable support lengths and fittings mechanically and to connect them to the structure, such as a room ceiling, a wall, the floor or a steel girder. Examples of support elements include wall and support brackets, suspended supports and centre suspensions.

Mounting elements are used to attach or fasten other elements to cable supports and fittings. For example, a mounting plate is often used for junction boxes or device supports.

The standard defines **accessories** as components such as barrier strips, covers or cable protection rings.

The standard determines **external influences** to be the



Cable support lengths

Cable trays, mesh cable trays or cable ladders

Fittings change the direction or dimension

Bend, T piece, cross-over

Support elements

Wall and support brackets, suspended support, centre suspension

presence of water, oil, construction materials, corrosive or soiling substances. By contrast, external mechanical forces, such as snow, wind or other environmental risks, are not included and are not taken into account by the standard. These additional loads, such as wind, snow and water, must be evaluated specially by the erection engineer for each construction project.

The **support distance** is the distance between the centres of two adjacent support elements. Put simply, the support spacing is the distance between the brackets.

An **external fastening element** (e.g. screw tie) is used to fasten support elements to supporting parts of the building structure and, in the sense of the standard, is not a part of the cable support system and is thus standardised elsewhere.

1.2 Corrosion and corrosion protection

Generally, a distinction is made between the following corrosion mechanisms:

Surface corrosion

- Unprotected, unalloyed steel oxidises extensively through moisture and oxygen
- Classic rust formation on steel
- If the rust formation location is limited, then this is termed hole or sink corrosion

Gap corrosion

- This affects unalloyed steel and stainless steel (this also applies if the gap is caused by plastic on steel)
- Caused by moisture in narrow gaps (< 1 mm)
- The electrolyte in the gap "acidifies" (i.e. the pH value falls), the electrolyte on the outside becomes alkaline (i.e. the pH value increases)
- Reaction products form, which can finally be seen as rust, hollowing out the gap



Gap corrosion on an enclosure. Through the progressing underlying rust the coating is damaged (source: OBO Bettermann)

Contact or bi-metallic corrosion

- Caused by the different electrochemical potentials of two metals (e.g. zinc and VA)
- Difference between precious metals and base metals
 - Precious metals: Electrochemical potential > 0
 - Base metals: Electrochemical potential < 0
- The baser partner oxidises
- Observe the area rule:
 - Good ratio: Base large, precious small
 - Poor ratio: Precious large, base small



A galvanised washer and a stainless steel nut have caused a poor surface ratio (source: OBO Bettermann)

Hole corrosion on stainless steels

- The passive layer of the stainless steels is harmed, primarily due to chloride
- Local spot corrosion can form, which hollows out the steel at the affected point
- In addition, tension crack corrosion can occur if there are tensions in the material (material cracks along the grain borders)

Electrochemical series of the metals

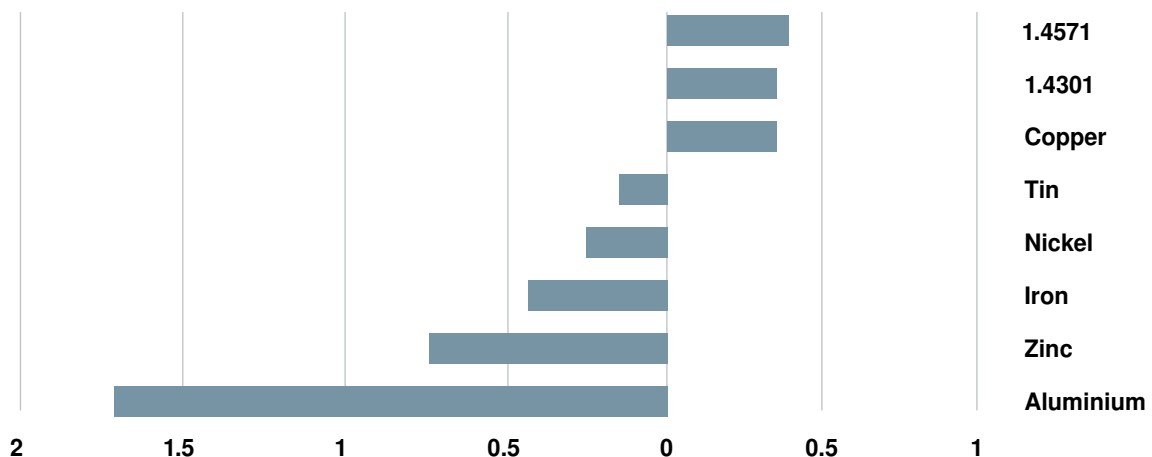

Corrosion of galvanisations

- Zinc uses carbon from the air to form a protective zinc carbonate covering layer after a few days
- If the zinc surface is exposed to moisture, then white rust will form before the covering layer can form
- Zinc is particularly prone to corrosion if salts exist (usually chloride, sulphate). This causes the zinc to be removed very quickly, meaning that the steel is unprotected



Light white rust on a hot-dip galvanised construction (source: Institut Feuerverzinken)

Surfaces		
G	FS	FT/(DD)
Electrogalvanised	Strip galvanised	Hot-dip galvanised/(Double Dip)

Materials		
A2	A4	A5
Stainless steel	Stainless steel	Stainless steel

Special solutions (on request)	
FTSO	FSK/FTK
Special layer thickness	Plastic coating

1.3 Surfaces

The following galvanisation surfaces can be applied to improve corrosion protection:

Electro-galvanisation

- Application of the zinc covering using an electrolysis method (direct current)
- Normal layer thicknesses, approx. 5–15 µm
- Retreatment normally in the form of passivation and/or sealing

Standards: DIN EN ISO 19598 & DIN EN ISO 4042

Applications: Interior areas without harmful substances, e.g. offices, sales areas – corrosiveness category according to DIN EN ISO 12944-2: C1

Examples: Mesh cable trays and connection elements

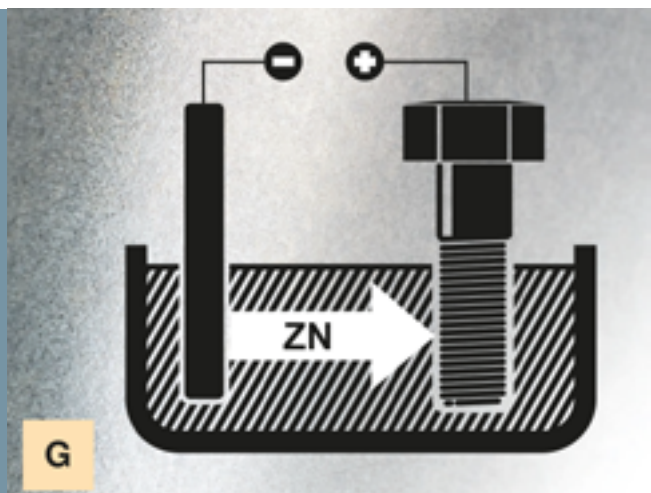

Strip galvanisation

- During the strip galvanisation process, also termed Sendzimir galvanisation, the steel strip is galvanised in a continuous process
- Materials: DX51D
- Normal layer thicknesses (Z 275) approx. 13–27 µm
- Retreatment of the coil possible in the form of passivation and/or sealing

Standards: DIN EN 10346

Applications: Indoor areas, in which condensation can occur, e.g. sports halls or warehouses – corrosiveness category according to DIN EN ISO 12944-2: Up to C2

Examples: cable trays, covers

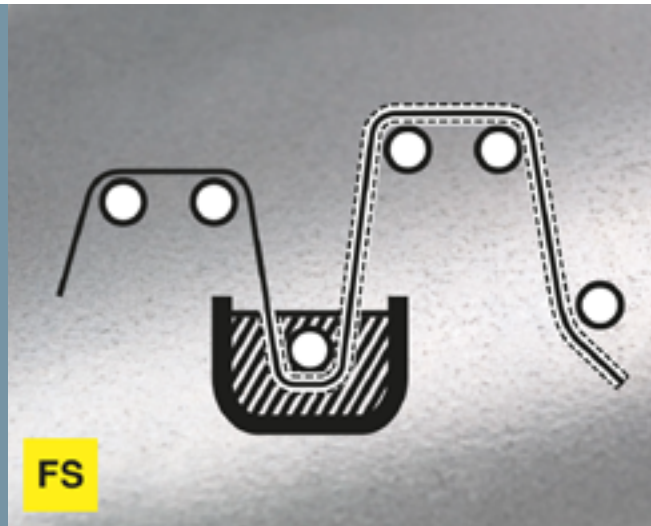

Hot-dip galvanisation

- The fully formed product is coated using a dipping method
- Materials: C9D, DC01, DD11, S235JR
- Normal layer thicknesses, approx. 45–85 µm

Standards: DIN EN ISO 1461

Applications: Indoor areas with a certain level of moisture and impurity, outdoor areas with medium levels of contamination, e.g. laundries, urban atmosphere – corrosiveness category according to DIN EN ISO 12944-2: To C3 (depending on layer thickness, up to C4)

Examples: Cable ladders, mesh cable trays, suspended supports and brackets



Hot-dip galvanising (Double Dip)

- Zinc-aluminium coating according to DIN EN 10346
- The material to be galvanised then passes through two baths: The first contains pure zinc, the second a zinc-aluminium alloy

Standards: DIN EN 10346

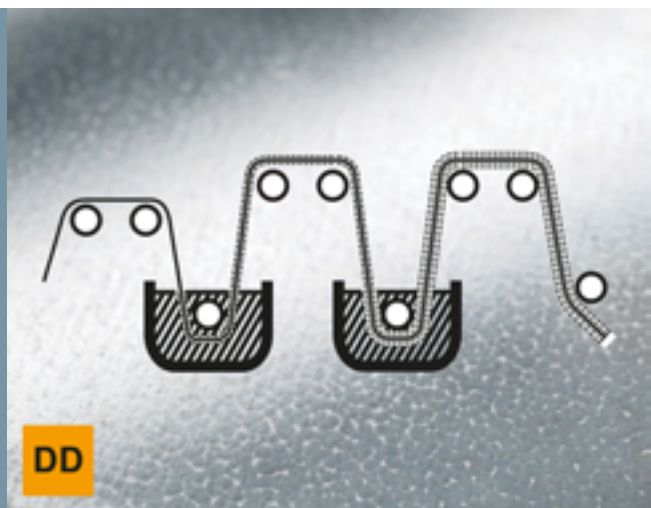

Zinc slat coating

- Processing of untreated steel to small parts, such as screws or washers
- Subsequent coating in the immersion spinning method, with an anorganic, zinc and aluminium-rich substance
- Coating thickness: 5–20 µm
- Cathodic corrosion protection is forgiving of small scratches, e.g. due to transport or mounting

Standard: DIN EN 13858, DIN EN ISO 10683

Applications: interior, exterior

Examples: connection elements, fastening elements

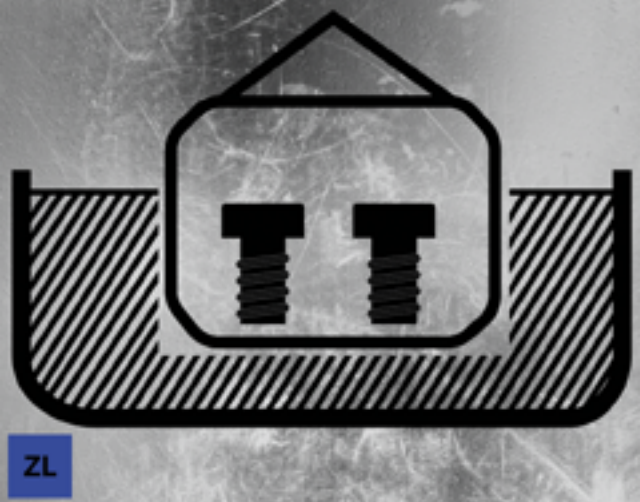

Plastic coating

- Plastic coating through electrostatically charged plastic powder
- Coating for the purpose of corrosion protection or for decorative reasons
- Particularly good adhesion through pretreatment of the components with different fluids
- Plastic powder made of epoxy and/or polyester resins, as well as polyurethane
- Normal layer thicknesses, approx. 70–100 µm
- Coating of various system components possible with the following surfaces:
 - Strip galvanised (FS)
 - Hot-dip galvanised (FT)
 - Electro galvanised (G)
 - Aluminium (Al)

Standards: DIN 55633/55634

Applications

Corrosion protection:

- Hot-dip galvanised system components with coating (Duplex)
- Very resistant to moisture, impurities and chemical influences
- Buildings with continuous condensate formation and heavy impurities
- Corrosiveness category according to DIN EN ISO 12944-2: Up to C5

Decorative reasons:

- Special visual requirements, appropriate to the colour design of the structure
- Coloured separation or assignment of different functions
- Available in all RAL colours



1.4 Materials

Stainless/rustproof steel

- The entry of oxygen causes a chromium oxide layer to form (passive layer), which protects against corrosion
- If the passive layer is damaged, e.g. by cutting, it forms again through further entry of oxygen
- Materials according to the alloy composition:
 - A2:
 - 1.4301 (AISI 304)
 - 1.4303 (AISI 305/308)
 - 1.4310 (AISI 301)
 - 1.4567 (AISI 304Cu)
 - A4:
 - 1.4401 (AISI 316)
 - 1.4404 (AISI 316L)
 - 1.4435 (AISI 316L)
 - 1.4571 (AISI 316Ti)
 - 1.4578
 - A5:
 - 1.4529
 - 1.4547
 - 1.4462
- Standard: EN 10088
- Corrosiveness category according to DIN EN ISO 12944-2:
 - A2: To C3
 - A4: To C4
 - A5: To CX

Overview of key alloy elements

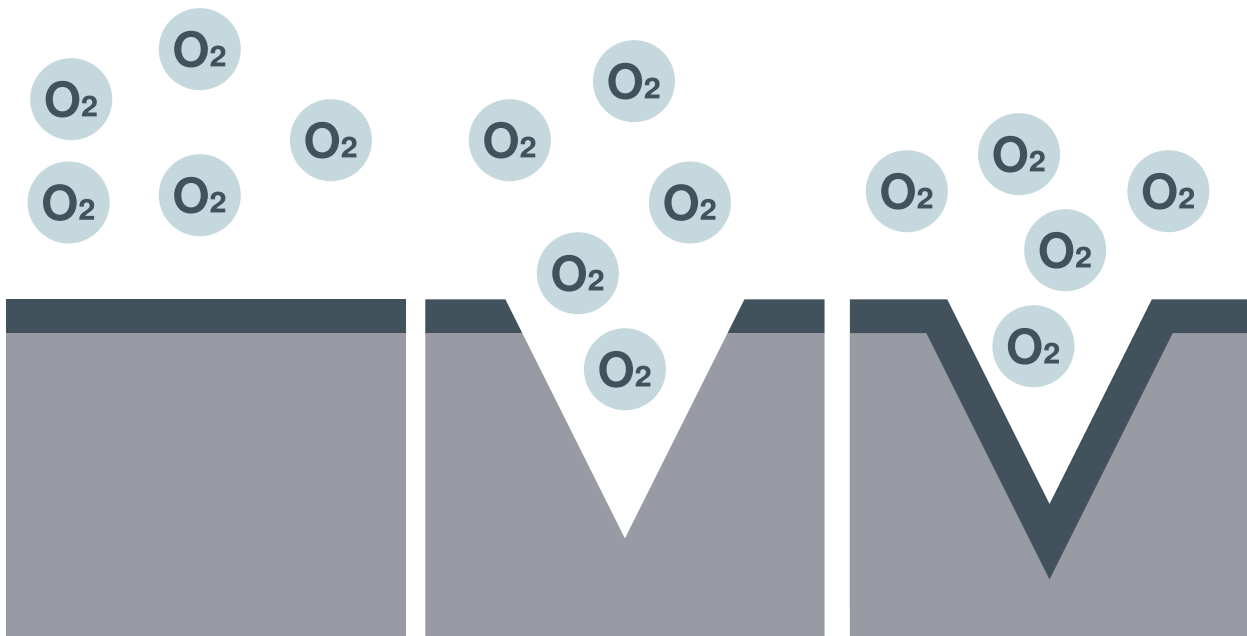

Element	Properties in the steel
Nickel	<ul style="list-style-type: none"> ▪ Stabilises the structure (austenite former) ▪ Increases stability and toughness ▪ Increases resistance to tension crack corrosion
Molybdenum	<ul style="list-style-type: none"> ▪ Increases the resistance to pitting ▪ Increases resistance to tension crack corrosion
Titanium	<ul style="list-style-type: none"> ▪ Stabilises the structure (carbide former) ▪ Increases resistance to intercrystalline corrosion
Nitrogen	<ul style="list-style-type: none"> ▪ Stabilises the structure (austenite former) ▪ Increases stability





1.5 Corrosiveness categories according to DIN EN ISO 12944-2:2018

Corrosiveness category	Mass loss/thickness reduction relative to the area (after the first year of warehouse removal)				Example of typical environments (only for information purposes)	
	Unalloyed steel		Zinc		Open air	Interior
	Mass loss g/m ²	Thickness reduction μm	Mass loss g/m ²	Thickness reduction μm		
C 1 Negligible	≤ 10	≤ 1.3	≤ 0.7	≤ 0.1	–	Heated building with neutral atmosphere, e.g. offices, sales areas, schools, hotels
C 2 Low	> 10 to 200	> 1.3 to 25	> 0.7 to 5	> 0.1 to 0.7	Atmosphere with low degree of impurity: usually rural areas	Unheated buildings, in which condensation can occur, e.g. warehouses, sports halls
C 3 Medium	> 200 to 400	> 25 to 50	> 5 to 15	> 0.7 to 2.1	Urban and industrial atmosphere with medium sulphur dioxide load; and coastal atmosphere with low salt load	Production rooms with high humidity and a certain amount of air impurities, e.g. food processing plants, laundries, breweries, dairies
C 4 Heavy	> 400 to 650	> 50 to 80	> 15 to 30	> 2.1 to 4.2	Industrial atmosphere and coastal atmosphere with medium salt load	Chemical plants, shipyards near the coast and harbours
C 5 Very heavy	> 650 to 1,500	> 80 to 200	> 30 to 60	> 4.2 to 8.4	Industrial areas with high humidity and aggressive atmosphere and coastal atmosphere with high salt load	Buildings or areas with almost continuous condensation and with high levels of impurities
C X Extreme	> 1,500 to 5,500	> 200 to 700	> 60 to 180	> 8.4 to 25	Offshore areas with high salt load and industrial areas with extreme humidity and aggressive atmosphere, as well as subtropical and tropical atmospheres	Industrial areas with extreme humidity and aggressive atmosphere

1.6 Typical environments and recommended surfaces/materials

					
Zinc removal: < 0.1 µm/a		Zinc removal: > 0.1 to 0.7 µm/a		Zinc removal: >0.7 to 2.0 µm/a	
Examples of typical environments					
Open air –	Interior Heated building with neutral atmosphere	Open air Atmosphere with low degree of impurity	Interior Unheated build- ings, in which condensation can occur	Open air Urban and indus- trial atmosphere with medium sulphur dioxide load	Interior Production rooms with high humid- ity and a certain amount of air impurity
Recommended surfaces/materials					
Electrogalvanised (G)		Strip galvanised (FS)/ zinc-aluminium alloy (DD)		Hot-dip galvanised (FT)/ stainless steel A2	
Layer thickness: 2.5 to 10 µm		Layer thickness: approx. 20 µm		Layer thickness: approx. 40 to 60 µm	

					
Zinc removal: 2.0 to 4.0 µm/a		Zinc removal: 4.0 to 8.0 µm/a		Zinc removal: 8.0 to 25 µm/a	
Examples of typical environments					
Open air Industrial atmos- phere and coastal atmosphere with medium salt load, shipyards near the coast	Interior Chemical plants, shipyards near the coast	Open air Industrial areas with high humidity and aggressive atmosphere and coastal atmos- phere with high salt load	Interior Buildings or areas with almost continuous condensation	Open air Offshore areas with high salt load and industrial area with extreme humidity	Interior Industrial areas with extreme humidity and aggressive atmosphere
Recommended surfaces/materials					
Stainless steel A2		Stainless steel A4		Stainless steel A5	
Rustproof		Approved acid-resistant		Approved high resistance	

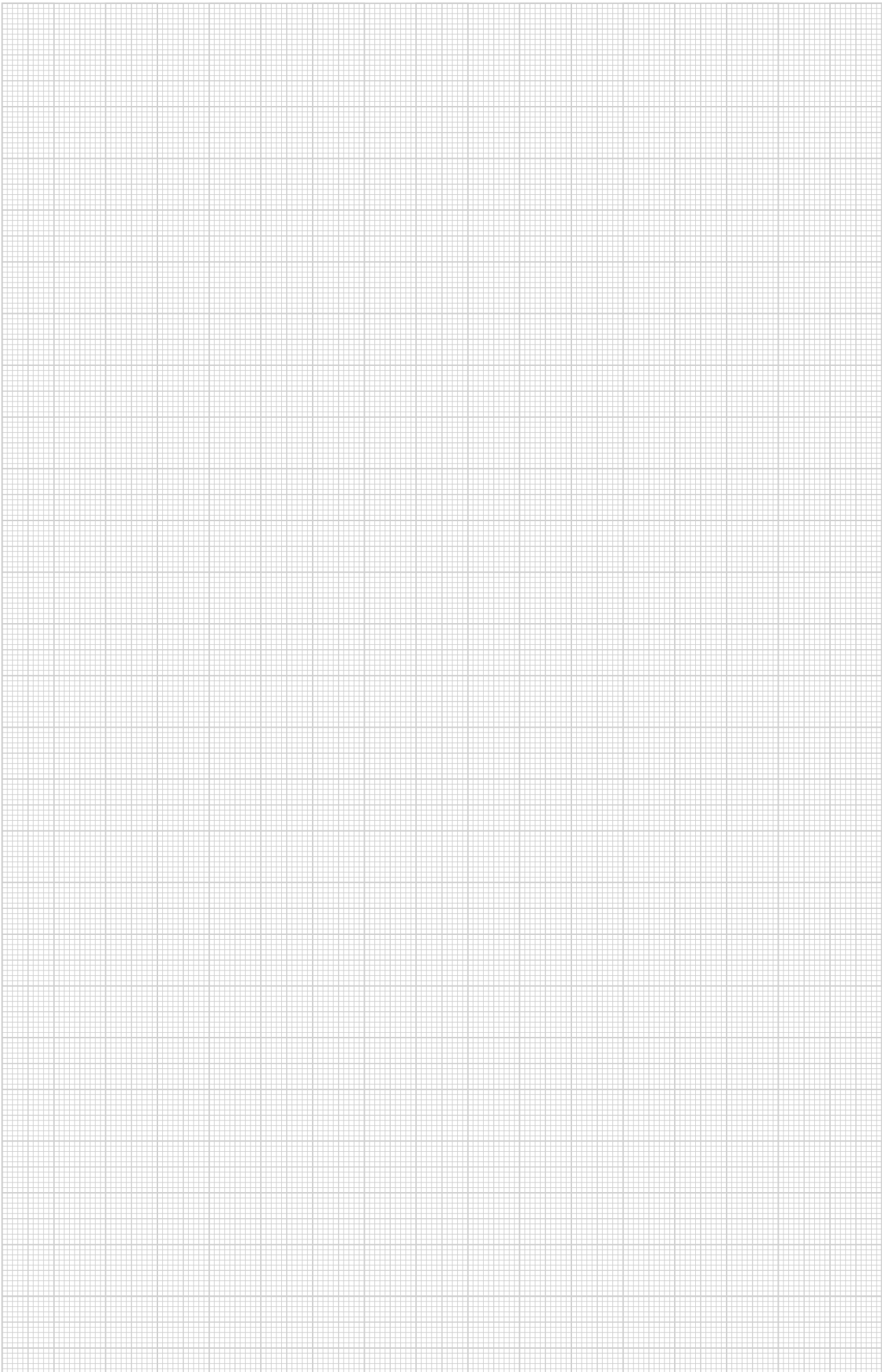

2. System selection

This chapter deals with the adequate selection of a cable support system according to the specific application. OBO Bettermann is a comprehensive systems provider, laying particular emphasis on all the products described below in the field of cable support systems.

2.1 Mounting systems	15
2.2 Cable tray systems	15
2.3 Mesh cable tray systems	15
2.4 Cable ladder systems	15
2.5 System application	15
2.6 Selection of the correct system	16
2.6.1 Determining the cable volume	16
2.6.2 Calculating the cable load	16
2.6.3 Determining the usable cross-section	17
2.6.4 Calculating the cable weight	17
2.6.5 Selection of the cable support system	18
2.6.6 Preselecting the overall system	20
2.6.7 Additional information on bracket mounting	21
2.6.8 Selecting the mounting system according to the load capacity	21
2.6.9 Final check of anchor system	22

2.1 Mounting systems

The mounting systems contain the following product areas:

Universal systems for cable support structures are used for small loads. The systems are suspended from the ceiling with threaded rods, stand-off brackets allow raised floor mounting of cable trays, ladders and mesh cable trays. The universal systems comprise ceiling brackets, trapezoidal fastenings, centre suspensions, suspension brackets and stand-off brackets.

U support systems for cable support structures comprise the light-duty US 3 system, the medium-duty US 5 system and the heavy-duty US 7 system. The different systems are designed for light, medium-weight and heavy loads. The U support systems can be used as ceiling suspension, floor stand-off or as construction profiles. The systems comprise U hanging supports, wall and support brackets, head plates, U supports and U support connectors.

I support systems for cable support structures are used to bridge large loads and support spacings and to create complex section routes. The systems allow large support spacings of wide span systems or the multilayer arrangement of cable trays and cable ladder systems. The systems comprise I hanging supports, support brackets, head plates, I supports and I support connectors, as well as carrier lugs and mounting angles. The high load capacity of all the system components and the wide range of accessories permit the mounting of complex structures.

All the systems can, depending on the material and surface version, be used in interior and exterior areas.

2.2 Cable tray systems

The cable tray is suitable for universal cable routing. From low-voltage cabling to power supplies, from data cables to telecommunications networks. A full product range, with suitable system components, can create perfect solutions for any task. No matter whether used in dry inner areas or in aggressive atmospheres: Different surface versions and materials ensure safe corrosion protection. Side heights of 35, 60, 85 and 110 mm are available, through to special cable tray systems with a 30% perforation amount and large insertion and exit points. Depending on the system, screwable or lockable cable trays with quick connection are available. With the practical and time-saving Magic system, cable trays can be interconnected without tools and without screws.

2.3 Mesh cable tray systems

OBO mesh cable tray systems stand out through their high load capacity and good ventilation. They can be used universally. The mesh cable trays are suitable for the installation of power cables and cables in various areas of application. The grid spacings mean that cables can be inserted and run out in various directions. The easily separable wires and the bending capacity of the mesh cable trays enable the simple creation of bends, branches and exits. Four different mesh cable tray types are available, depending on the requirements, area of application and cable quantity. The innovative Magic connection system of the GRM and G-GRM mesh cable tray types permit toolless section mounting.

2.4 Cable ladder systems

OBO cable ladder systems stand out through their high load capacity and good ventilation. This makes them particularly suited to the installation of power cables and cables with large cross-sections. They can be used universally. Due to their continuous rail and rung perforation, they offer countless mounting options, e.g. integrated fastening of cables on the rungs using OBO clamp clips.

2.5 System application

In general terms, the individual areas of application can be described as follows:

Cable tray systems: From weak current cabling through to the power supply

Mesh cable tray systems: IT cabling, telephone cabling and control cables; also suitable for use in false ceilings and raised floors

Cable ladder systems: Cables and power cables with large cross-sections, which can be fastened to rungs with clamp clips. The large load capacity and good ventilation ensure perfect cable routing.

Depending on the material, the systems can be used in indoor or outdoor areas.

2.6 Selection of the correct system

This chapter deals with the correct dimensioning and the final selection of a cable support system, depending on the application, according to various influencing factors, such as cable volume, cable weight, usable cross-section and other items.

2.6.1 Determining the cable volume

The term "cable" means a jacketed electrical cable for the transmission of electrical energy and data. Cables are given according to their nominal cross-section. The external diameter and usable cross-section depend on the nominal cross-section and the number of individual wires contained in the cable.

The diameter of the cable says little about the space requirements of a cable, as the arrangement can always cause certain air pockets and cavities. This means that, for simplicity, the squared space requirements are calculated using the formula $(2r)^2$.

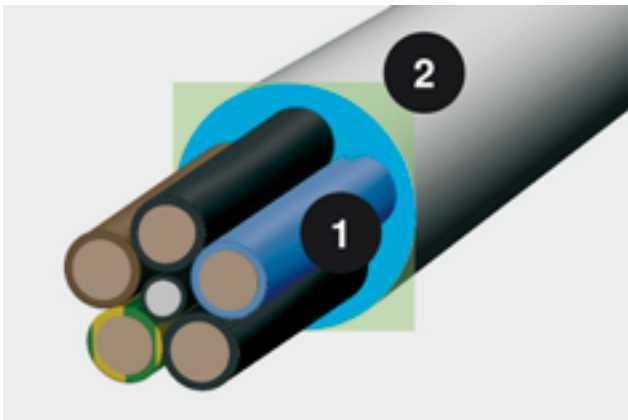
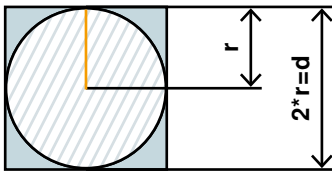

- 1 Diameter in mm
- 2 Space requirements in mm²

Space requirements = $(2r)^2$ = diameter²

Example:
 NYM-J 3 x 2.5: Cable diameter 9.50 mm
 $(9.50 \text{ mm})^2 = 90.25 \text{ mm}^2$

A list of cables with the corresponding usable cable cross-sections can be found in the "Industrial installations" planning aids. Alternatively, the value can be found in the data sheets of the appropriate cable manufacturers.

2.6.2 Calculating the cable load

The specifically occurring cable load is a value, which can be calculated with the help of the characteristic values of the available cable and the inclusion of the information offered in VDE 0639 Part 1 (Cable support systems).

The calculation of the specific cable load can be determined by dividing the weight of the cable (given in kg/m) by the usable cross-section of the cable (see above, given in mm²). This division is finally multiplied by the location factor 9.81 N/kg.

$$\text{Spec. cable load} = \frac{\text{Cable load} \left[\frac{\text{kg}}{\text{m}} \right]}{\text{Usable cross-section} [\text{mm}^2]} * 9.81 \frac{\text{N}}{\text{kg}}$$

This formula can be used to determine the specific cable load of each cable.

This is an example for **NYM-J 3x2.5**:

$$\text{Spec. cable load} = \frac{0.19 \frac{\text{kg}}{\text{m}}}{90.25 \text{ mm}^2} * 9.81 \frac{\text{N}}{\text{kg}} = 0.021 \frac{\text{N}}{\text{m} * \text{mm}^2}$$

In addition, it should be mentioned that, in VDE 0639, the heaviest listed cable has a specific cable load of 0.028 N/m*mm². This is an insulated heavy current cable **NYJ-J 4x95**. Higher specific weights can only be achieved by cables with large cross-sections, which are less bendable and thus can support themselves better and, on account of their larger diameter, have a lower filling co-efficient for the usable tray cross-section.

Alternatively to the calculation of the cable load, it is also possible to use empirical values as a guide. Therefore, it can generally be assumed that a system of, for example, 60 mm rail height per metre of cable tray or cable ladder will produce a value of 15 kg per 100 mm width.



100 mm = 15 kg/m



200 mm = 30 kg/m



300 mm = 45 kg/m



400 mm = 60 kg/m



500 mm = 75 kg/m



600 mm = 90 kg/m

2.6.3 Determining the usable cross-section

The usable cross-section of a cable support system is aligned to the appropriate dimension. For simplicity, the area calculation using the cable support width and height can be used for rough planning. OBO also shows the usable cross-section of each cable support system in the catalogue.



Below, the appropriate usable cross-sections of the individual cable system types can be seen at a glance. The differing structure of the systems mean that they also have different usable cross-sections. During dimensioning, we recommend a space reserve of approx. 30%.

Height [mm]	35	60	85	110
Width [mm]	Usable cross-section [mm²]			
	cable trays			
100	3,300	5,800	8,300	10,800
150	5,050	8,800	12,500	16,100
200	6,800	11,800	18,600	21,800
300	10,300	17,800	25,300	32,800
400	-	23,800	33,800	43,800
500	-	29,800	42,300	54,800
600	-	35,800	50,800	60,300

Height [mm]	60	110
Width [mm]	Usable cross-section [mm²]	
	Cable ladders	
200	9,800	18,000
300	14,800	27,000
400	19,800	36,000
500	24,800	45,000
600	29,800	54,000

Height [mm]	35	55	105
Width [mm]	Usable cross-section [mm²]		
	Mesh cable trays		
100	3,500	4,000	8,200
150	5,250	6,300	13,000
200	7,000	8,700	17,500
300	10,500	12,900	26,800
400	-	17,500	36,300
500	-	22,000	45,900
600	-	26,500	55,400

2.6.4 Calculating the cable weight

DIN VDE 0639 P1 (Cable support systems) offers a formula for the calculation of a maximum approved cable load. The formula contains the specific cable load which was the subject of the previous chapters, as well as the usable cross-section of the cable support system.

$$\text{Cable load (F)} = \frac{0.028 \text{ N}}{\text{m} \cdot \text{mm}^2} * \text{Usable cross-section of the cable tray [mm}^2\text{]}$$

Example for a RKSM 60x300 cable tray

$$\begin{aligned} \text{Cable load (F)} &= \frac{0.028 \text{ N}}{\text{m} \cdot \text{mm}^2} * 17,800 \text{ mm}^2 \\ &= 498.4 \frac{\text{N}}{\text{m}} = 0.5 \frac{\text{kN}}{\text{m}} \approx 50 \frac{\text{kg}}{\text{m}} \end{aligned}$$



As an overview, the following tables show the determined maximum occurring cable loads per dimension (rounded):

Height [mm]	35	60	85	110
Width [mm]	Max. occurring cable load [kN/m ≈ 100 kg/m]			
	cable trays			
100	0.09	0.16	0.23	0.30
150	0.14	0.25	0.35	0.45
200	0.19	0.33	0.52	0.61
300	0.29	0.50	0.71	0.92
400	-	0.67	0.95	1.23
500	-	0.83	1.18	1.53
600	-	1.00	1.42	1.69

Height [mm]	60	110
Width [mm]	Max. occurring cable load [kN/m ≈ 100 kg/m]	
	Cable ladders	
200	0.27	0.50
300	0.41	0.76
400	0.55	1.01
500	0.69	1.26
600	0.83	1.51

Height [mm]	35	55	105
Width [mm]	Max. occurring cable load [kN/m ≈ 100 kg/m]		
	Mesh cable trays		
100	0.10	0.11	0.23
150	0.15	0.18	0.36
200	0.20	0.24	0.49
300	0.29	0.36	0.75
400	-	0.49	1.02
500	-	0.62	1.29
600	-	0.74	1.55

2.6.5 Selection of the cable support system

OBO offers load details including informative load tables, using which the suitable cable tray, mesh cable tray or cable ladder can be selected.

Finding the appropriate system for the cable load

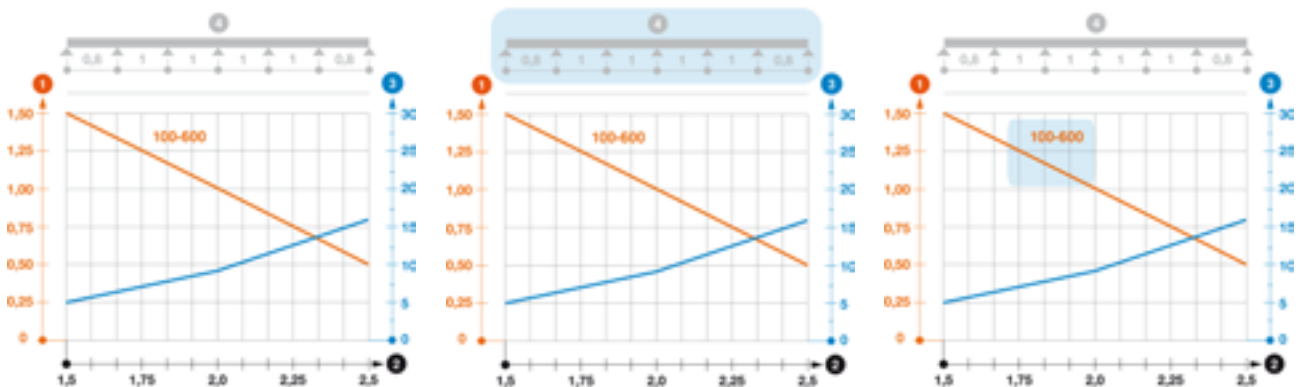

Load diagram legend

- ① = Load in kN/m without human load
- ② = Support width in m
- ③ = Rail bend in mm
- ④ = Schematic representation of the support widths during the testing procedure
- = Approved load according to support width for the different tray widths
- = Rail bend depending on the support width

Information 1: The testing process

The basic principles of the tests of OBO cable support systems come from VDE 0639 Part 1 and DIN EN 61537. The purpose of the tests is to determine the maximum load capacities for each component, depending on parameters such as component width, support spacing, etc. and to present this in a diagram to be included with each component. The area highlighted in blue in the above example schematises the experiment set-up with a variable support spacing (L) in the central area and a factor of $0.8 \times L$ at the front and rear ends of the cable tray.

Information 2: Load curves for selected cable tray or cable ladder widths

The load capacity of the cable trays according to the support width can be read off in the diagram using load curves – here, shown as an example for a cable tray with the tray widths 100 to 600 mm. It may occur that in the load curves, width differences must be made, allowing multiple curves to be visible simultaneously in the diagram. A key factor for the load capacity of the cable trays is (in addition to the support spacing and slant height) the material thickness, which varies according to type.

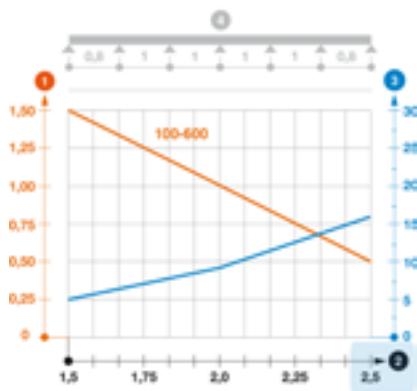

Information 3: Possible support spacings

The theoretically possible support spacings for the cable tray can be read off on the axis at the foot of the table. Using the load curves, it is easy to read off to what extent the load capacity of the system falls as the support spacing grows. On all OBO cable support systems (with the exception of the wide span trays), we recommend not exceeding a support spacing of 1.5 m if possible.

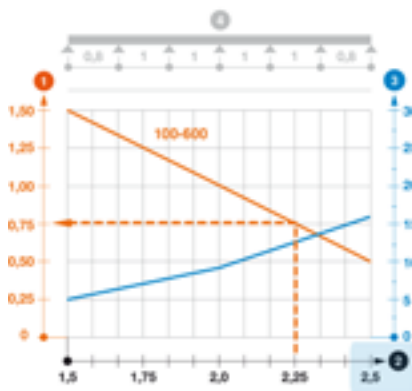

Information 4: Ratio of load/support width

Which load is possible at which support spacing? With the diagram, you can find the appropriate information at a glance. In our example (with the blue background), a span of 2.25 m for the cable tray produces a maximum load capacity of 0.75 kN for each running metre of cable tray. Please note that in this example, the volume of the cable tray may exceed the permitted load. For this reason, if at all possible do not exceed the recommended OBO standard support spacing of 1.5 m.

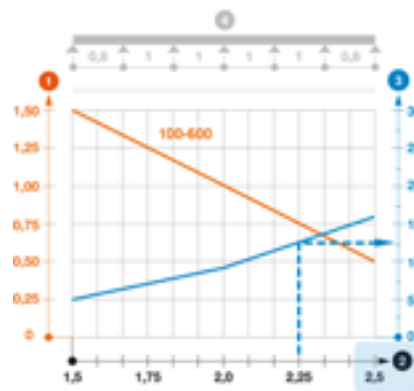

Information 5: W = Rail bend

To what extent does the load on a cable tray cause the rail to bend? This information is supplied by the blue curve (w) in millimetres (orientation values on the axis on the right-hand side of the diagram).

The course of the blue curve clearly shows how quickly the cable tray will sag as the support spacing increases. In our example, the bend at a support spacing of 2.25 m is shown, here approximately 12 mm.

Load

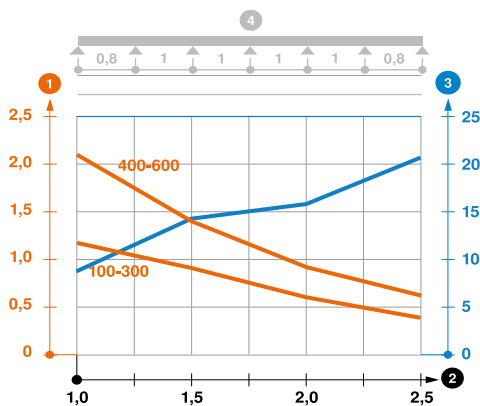

	1.0m kN/m	1.5m kN/m	2.0m kN/m	2.5m kN/m	Nema load class
RKSM 610 FS	1.2	0.9	0.6	0.4	8AA
RKSM 615 FS	1.2	1	0.6	0.4	8AA
RKSM 620 FS	1.2	1	0.55	0.4	8AA
RKSM 630 FS	1.2	1	0.55	0.4	8AA
RKSM 640 FS	2.1	1.35	0.8	0.6	8AA
RKSM 650 FS	2.1	1.35	0.8	0.6	8AA
RKSM 660 FS	2.1	1.4	0.8	0.6	8AA

Load diagram, cable tray type RKSM 60

- ① = Approved cable tray/ladder load in kN/m without human load
- ② = Support width in m
- ③ = Rail bend in mm at approved kN/m
- ④ = Load diagram for testing method
- = Load curve with cable tray/ladder width in mm
- = Rail bend curve depending on the support width

If necessary, the support spacing must be multiplied with the cable weight to be expected (see also the previous chapter)!

2.6.6 Preselecting the overall system

The following tables provide an overview of which fastening systems match which brackets.

Support	Hole Ø: Support	Bracket	Hole Ø: Bracket	Bolt	Item no.	Anchor	Item no.
US 3	11 mm	MWA 12 11-13*	11 mm	FRS 10x25 F 8.8	6407560	BZ3 8x75/0-20	3498683
	11 mm	AW 15 11-31	11 mm	FRS 10x25 F 8.8	6407560	BZ3 10x90/0-30	3498691
	11 mm	MWA 12 41	11 mm	DKS25 + SKS 10x90 F	6416446 + 6418252	BZ3 10x90/0-30	3498691
	11 mm	AW 15 41	11 mm	DKS25 + SKS 10x90 F	6416446 + 6418252	BZ3 10x90/0-30	3498691
	11 mm	AW 15 51-61	11 mm	Not possible with US 3	-	-	-

Support	Hole Ø: Support	Bracket	Hole Ø: Bracket	Bolt	Item no.	Anchor	Item no.
US 5	11 mm	MWA 12 11-13*	11 mm	FRS 10x25 F 8.8	6407560	BZ3 8x75/0-20	3498683
	11 mm	AW 15 11-31	11 mm	FRS 10x25 F 8.8	6407560	BZ3 10x90/0-30	3498691
	11 mm	AW 30 11 + 16	11 mm	FRS 10x25 F 8.8	6407560	BZ3 10x90/0-30	3498691
	11 mm	AW 30 21 + 31	13 mm	FRS 10x30 F + DIN 44011F	6407579 + 6408729	BZ3 12x110/0-35	3498703
	11 mm	MWA 12 41 + AW15 41	11 mm	DSK 45 + SKS 10x90 F	6416500 + 6418252	BZ3 12x110/0-35	3498703
	11 mm	AW 30 41	13 mm	DSK 45 + SKS 10x90 F	6416500 + 6418252	BZ3 12x110/0-35	3498703

Support	Hole Ø: Support	Bracket	Hole Ø: Bracket	Bolt	Item no.	Anchor	Item no.
US 7	14 mm	MWA 12 11-41*	11 mm	SKS 10x30 F + DIN 440 11F	3160742 + 6408729	BZ3 10x90/0-30	3498691
	14 mm	AW 15 11-41	11 mm	SKS 10x30 F + DIN 440 11F	3160742 + 6408729	BZ3 10x90/0-30	3498691
	14 mm	AW 30 11 + 16	11 mm	SKS 10x30 F + DIN 440 11F	3160742 + 6408729	BZ3 10x90/0-30	3498691
	14 mm	AW 30 21 + 31	13 mm	FRS 12x30 F	6406270	BZ3 12x110/0-35	3498703
	14 mm	AW 30 41-61	13 mm	DSK 61 + SKS 12x100 F	6416519 + 6418295	BZ3 12x110/0-35	3498703
	14 mm	AW 55 21-41	13.5 mm	DSK 61 + SKS 12x100 F	6416519 + 6418295	BZ3 12x110/0-35	3498703
	14 mm	AW 15 51-61	11 mm	DSK 61 + SKS 12x100 F + DIN 440 11	6416519 + 6418295 + 6408729	BZ3 12x110/0-35	3498703

*Screw 6407560 is contained in the scope of delivery for the MWA/MWAG and MWA-M brackets.

2.6.7 Support and bracket combinations

Bracket arrangement, one-sided

The basis for the recommendation is not the standard load capacity of the brackets, as tested according to DIN-EN 61537, but rather the realistically occurring loads of a standard cable support system.

A maximum of 15 kg/m per 100 mm of section width and a support distance of 2.0 m are applied. In the final versions, the total load capacity of the system must always be taken into account, including the anchor load capacities.

A spacer must always be used for support lengths > 600 mm and a bracket arrangement at the bottom end of the support.



Bracket without (left) and with spacer (right)

Always mount the brackets as follows:

- Always mount the truss-head bolt on the support side
- Always mount the nut with washer on the bracket side



2.6.8 Selecting the mounting system according to the load capacity

OBO also offers matching load details including informative load tables – using which the suitable cable tray, mesh cable tray or cable ladder can be selected – for the mounting systems such as universal systems, U support systems, I support systems and trapezoidal systems.

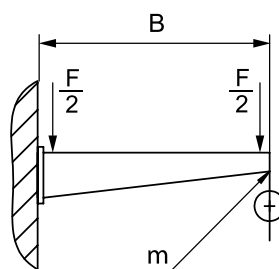

Characteristic load values for anchors for AW 15 wall and support brackets – wall fastening

Item on test	Force F (SWL)	Width B
AW 15 11 FT	1.5 kN	110 mm
AW 15 16 FT	1.5 kN	160 mm
AW 15 21 FT	1.5 kN	210 mm
AW 15 31 FT	1.5 kN	310 mm
AW 15 36 FT	1.5 kN	360 mm
AW 15 41 FT	1.5 kN	410 mm
AW 15 51 FT	1.5 kN	510 mm
AW 15 56 FT	1.5 kN	560 mm
AW 15 61 FT	1.5 kN	610 mm

Deformation measuring point m | According to IEC 61537, Chapter 10.8.1

Max. load F total = Cable weight + cable tray + bracket

Characteristic load values for anchors for AW 15 wall and support brackets – wall fastening

Load [kN]								
Bracket width [mm]	110	160	210	310	410	510	560	610
Anchor type								
BZ3 10x90/0-30	1.5	1.5	1.5	1.47	1.25	1.13	0.95	0.94

The stated values are based on cracked concrete of compressive strength C20/25. Please comply with the installation conditions of ETA (anchors).

Characteristic anchor load values for US 3 K support

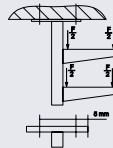
Single-sided load					
	Max. load [kN]				
	Bracket width [mm]				
	Anchor type	110	210	310	410
	BZ3 8x75/0-20	2.18	1.59	1.25	1.02
BZ3 10x90/0-30	3.05	2.00	1.49	1.18	

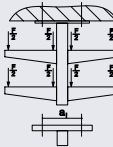
Double-sided load					
	Max. load [kN]				
	Bracket width [mm]				
	Anchor type	110	210	310	410
	BZ3 8x75/0-20	4.54	3.78	3.21	2.66
BZ3 10x90/0-30	7.17	5.96	5.07	4.14	

Max. load F_{total} = Cable weight + cable tray + bracket + suspended support. The table values for the two-sided load take the existing axis distance $a_i = 10$ cm into account. The stated values are based on cracked concrete of compressive strength C20/25. Please comply with the installation conditions of ETA (anchors).

Extensive details can be found in the OBO Industrial installations catalogue and the Industrial installations planning aid.

2.6.9 Final check of anchor system

The selection tables in Chapter 2.6.6 "Pre-selecting the overall system" and 2.6.8 "Selecting the mounting system according to the load capacity" already take the characteristic support values of the appropriate anchor systems into account. Therefore, the support values should be understood as static proof.

Standard anchoring depth

Loads and characteristic values	Anchoring depth	Drill hole Ø	Drill hole depth	Clamping strength	Permitted load area, tension zone
	mm	mm	mm	mm	kN
BZ3 8x75/0-20	45	8	55	10	4.5
BZ3 8x95/0-40	45	8	55	30	4.5
BZ3 8x165/55-110	45	8	55	100	4.5
BZ3 10x90/0-30	60	10	71	10	7.1
BZ3 10x110/0-50	60	10	71	30	7.1
BZ3 10x155/35-95	60	10	71	75	7.1
BZ310x180/60-120	60	10	71	100	7.1
BZ 10-150/230	60	10	75	150	4.3
BZ3 12x110/0-35	70	12	83	15	10
BZ312x180/30-105	70	12	83	85	10
BZ312x200/50-125	70	12	83	105	10
BZ 12-160/255	70	12	90	160	7.6
BZ3 16x135/0-35	85	16	102	15	13.4

Reduced anchoring depth

Loads and characteristic values	Anchoring depth	Drill hole Ø	Drill hole depth	Clamping strength	Permitted load area, tension zone
	mm	mm	mm	mm	kN
BZ3 8x65/0-10	35	8	45	10	3.5
BZ3 8x75/0-20	35	8	45	20	3.5
BZ3 8x95/0-40	35	8	45	40	3.5
BZ3 8x165/55-110	35	8	45	110	3.5
BZ3 10x70/0-10	40	10	51	10	4.3
BZ3 10x90/0-30	40	10	51	30	4.3
BZ3 10x110/0-50	40	10	51	50	4.3
BZ3 10x155/35-95	40	10	51	95	4.3
BZ310x180/60-120	40	10	51	120	4.3
BZ3 12x85/0-10	50	12	63	10	6.1
BZ3 12x110/0-35	50	12	63	35	6.1
BZ312x180/30-105	50	12	63	105	6.1
BZ312x200/50-125	50	12	63	125	6.1
BZ3 16x135/0-35	65	16	82	35	9

You can also refer to the DIBT/ETA for the load values.

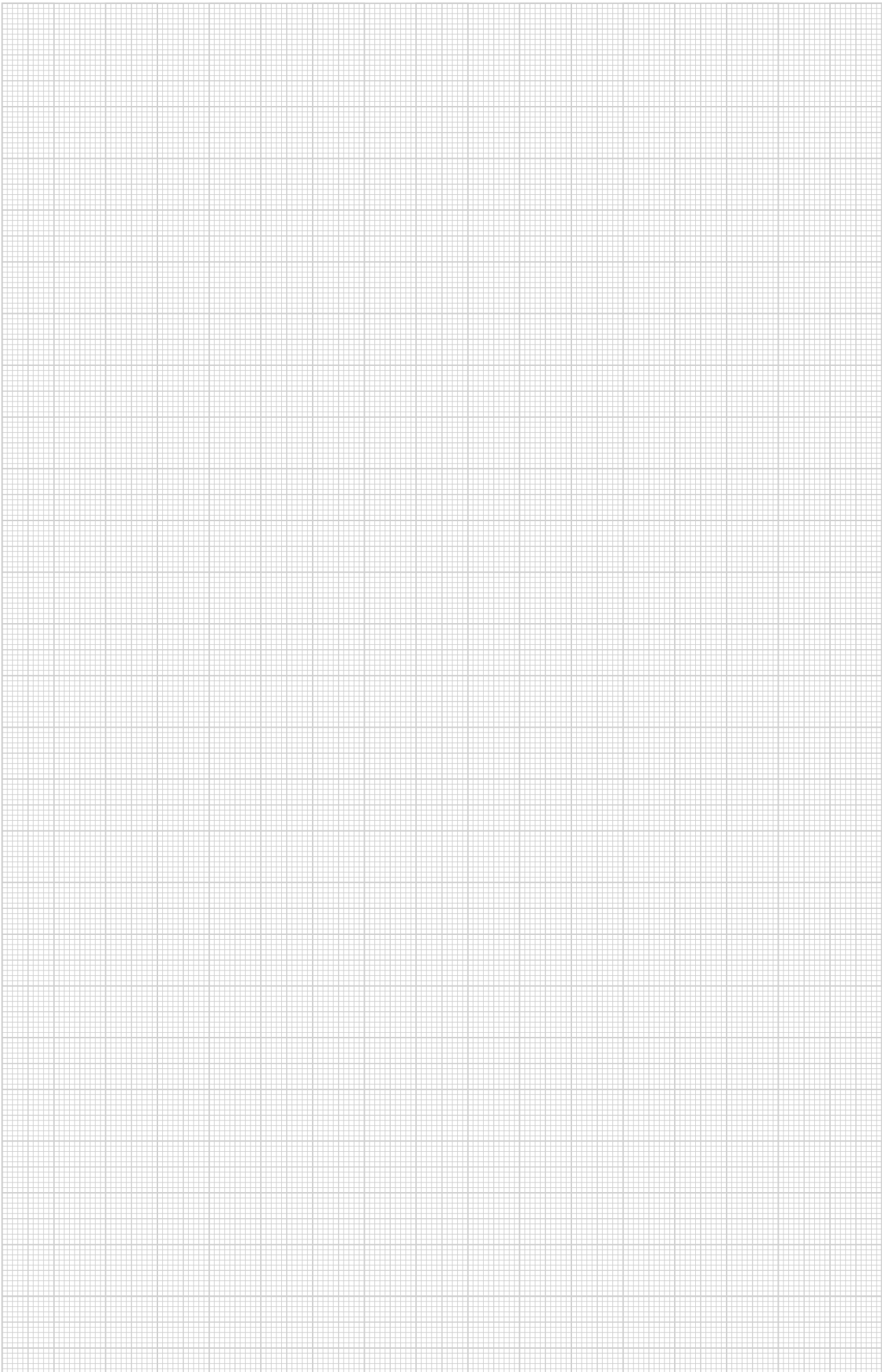

3. Mounting conditions

3.1 Tightening torques for bolts	25
3.2 Tightening torques for steel bolts with metric thread	25
3.3 Tightening torques for stainless steel bolts with metric thread	25

3.1 Tightening torques for bolts

Different tightening torques apply when mounting a cable support system. Please note that the specified torques are only intended as rough, non-binding guide values (see VDI 2230).



3.2 Tightening torques for steel bolts with metric thread

Thread	Tightness class 5.6	Tightness class 8.8
	Friction coefficient 0.14	Friction coefficient 0.14
M6	4.80 Nm	11.30 Nm
M8	11.60 Nm	27.30 Nm
M10	23.10 Nm	54.00 Nm
M12	40.40 Nm	93.00 Nm
M14	64.70 Nm	148.00 Nm
M16	100.70 Nm	230.00 Nm

3.3 Tightening torques for stainless steel bolts with metric thread

Thread	Resistance grade 70	Resistance grade 80
	Friction coefficient 0.20	Friction coefficient 0.20
M6	9.70 Nm	12.90 Nm
M8	23.60 Nm	31.50 Nm
M10	46.80 Nm	62.40 Nm
M12	81.00 Nm	108.00 Nm
M14	129.00 Nm	172.00 Nm
M16	201.00 Nm	269.00 Nm

Refer to the appropriate data sheets for the appropriate resistance classes of the products. These data sheets on our products are available for you to download at our website obo-bettermann.com.

4. Load values, product standard IEC 61537:2006

4.1 Terms	27
4.2 General requirements	27
4.3 Labelling and documentation	27
4.4 Classification	28
4.5 Mechanical load testing to determine the safe working load (SWL)	29
4.5.1 Cable support lengths as multi-field support	30
4.5.2 Cable support lengths as single-field support	30
4.5.3 Fittings	31
4.5.4 Brackets	31
4.5.5 Supports	31
4.6 Safe installation of supports with brackets	32
4.6.1 Electrical tests	32
4.6.2 Fire risks	33

4.1 Terms

In Germany, DIN EN 61537:2007 09 "Cable management – Cable tray systems and cable ladder systems" is the currently valid translation of IEC 61537:2006. It specifies the requirements and testing for cable support systems, which are intended to support and house cables, as well as other electrical resources in electrical installations or communication systems.

Currently, a new version of IEC 61537 is being worked on by an international committee of experts.

Refer to the third chapter "Characteristics of cable support systems" of the technical manual for more on the basic terminology of cable support systems.

4.2 General requirements

Besides precise testing requirements, the product standard also defines the general requirements for the system.

The dimensions and structure of the cable support systems must be such that, when used as intended according to the manufacturer's data (this also includes the mounting instructions), reliable support for the cables within is guaranteed. The system may not represent any impossible risks or dangers for either the user or the cables. In general, cable support systems are not intended to be used to support people or other spot loads.

To achieve safe, stable results in practice, each test is carried out with at least three test objects. All of them must pass.

The standard requires a standard laboratory temperature of 20 °C as the testing temperature. As most products in this area are made of steel, the temperature plays a considerably less significant role for regular applications. The key mechanical characteristic values determined by this standard can, in many areas, be regarded as non-sensitive compared to the temperature. By contrast, with plastic systems, the user should check carefully whether a system is suitable for the intended temperature and has been tested.

4.3 Labelling and documentation

Each system component must be permanently legibly labelled with the name or trademark of the manufacturer and a product identification (e.g. type or article number). Alternatively, the labelling can be applied to the smallest packaging unit.

The manufacturer must supply mounting instructions on the correct, safe installation. These include information on the thermal expansion properties, the classification details according to Chapter 6, information on equipment for equipotential bonding and product dimensions (total cross-sectional area, usable base width, usable height when the cover is mounted, the smallest inner radius on fittings, perforation and hole dimensions of the cable support lengths, as well as rung dimensions, rung distances and their perforation). In addition, the documentation must provide information on the tightening torques of the screw connections.

With regard to the cable support lengths, the manufacturer must provide information on the limit values for the final support spacing, position and type of the connection within the span width as well as the safe working load (SWL) of the cable support lengths and connections.

The cable support lengths can be mounted differently. On the one hand, they can be mounted on the horizontal plane with a horizontal direction of movement. Here, a further distinction is made between individual support spacings (single-field support) or multiple support spacings (multi-field support). On the other hand, it is possible to mount on the vertical plane. Here, a distinction is made between a vertical direction of movement (so-called rising sections) and the horizontal direction of movement (normal power station application).

With fittings, the SWL must be declared if they are not supported directly, along with the distance beside the fittings to the next supports.

In addition, the safe working load must be stated for brackets and supports.

4.4 Classification

All the cable support systems are classified using a numerical system in accordance with Chapter 6 of the product standard IEC 61537. This allows the user to detect easily which properties a cable support system offers.

6.1	Material
6.1.1	Metallic component
6.1.2	Non-metallic component
6.1.3	Mixed construction

6.2	Resistance against the spread of flames
6.2.1	Flame-spreading
6.2.2	Not flame-spreading

6.3	Electrical conduction property
6.3.1	Without electrical conduction properties
6.3.2	With electrical conduction properties

6.4	Electrical conductivity
6.4.1	Electrically conductive system component
6.4.2	Electrically non-conductive system component

6.5	Corrosion/surfaces
6.5.1	Non-metallic system components
6.5.2	Steel with metallic surface treatment or rustproof steel

Classes 0–9D see table

Class	Reference material and surface treatment
0 ^a	None
1	Galvanic zinc coating with a minimum thickness layer of 5 m
2	Galvanic zinc coating with a minimum thickness layer of 12 m
3	Hot-dip galvanised (strip galvanised) to Level 275 according to EN 10327 and EN 10326
4	Hot-dip galvanised (strip galvanised) to Level 350 according to EN 10327 and EN 10326
5	Hot galvanised (piece galvanised) with a minimum layer thickness of 45 µm according to ISO 1461
6	Hot-galvanised (piece galvanised) with a minimum layer thickness of 55 µm according to ISO 1461
7	Hot-galvanised (piece galvanised) with a minimum layer thickness of 70 µm according to ISO 1461
8	Hot galvanised (piece galvanised) with a minimum layer thickness of 85 µm according to ISO 1461 (normally high-alloy silicon steel)

9A	Rustproof steel, manufactured according to ASTM: A240/A 240M – 95a designation S30400 or EN 10088 Level 1-4301 without end treatment ^b
9B	Rustproof steel, manufactured according to ASTM: A240/A 240M – 95a designation S30400 or EN 10088 Level 1-4404 without end treatment ^b
9C	Rustproof steel, manufactured according to ASTM: A240/A 240M – 95a designation S30400 or EN 10088 Level 1-4301 without end treatment ^b
9D	Rustproof steel, manufactured according to ASTM: A240/A 240M – 95a designation S30400 or EN 10088 Level 1-4404 without end treatment ^b

^a For materials that do not have a declared corrosion resistance classification.

^b The end treatment process is used to improve the protection against gap corrosion and the contamination of other steels.

6.5	Corrosion/surfaces
6.5.3	Aluminium alloy or other metals
6.5.4	With metallic and organic coating

6.6	Temperatures
6.6.1	Minimum temperature –50 °C / –40 °C / –20 °C / –15 °C / –5 °C / +5 °C
6.6.2	Maximum temperature +150 °C / +120 °C / +105 °C / +90 °C / +60 °C / +40 °C

6.7	Perforation of the base area of the cable tray length
A	≤ 2%
B	> 2%
C	> 15%
D	> 30% (IEC 60364 5 52)

6.8	Perforation of the base area of the cable tray length
X	≤ 80%
Y	> 80%
Z	> 90% (IEC 60364 5 52)

6.9	Impact resistance
6.9.1	Up to 2 J
6.9.2	Up to 5 J
6.9.3	Up to 10 J
6.9.4	Up to 20 J
6.9.5	Up to 50 J

4.5 Mechanical load testing to determine the safe working load (SWL)

An important core task of the standard is to verify the data produced on the safe working load in a comparable and reproducible framework. This is achieved using various test methods. Of importance for the practical application is that the connectors are to be arranged in the manner described in the instructions or data sheets of the manufacturer, as otherwise the safe working load cannot be guaranteed.

Generally, two tests must be carried out – the minimum temperature test and the maximum temperature test. With steel components, it is sufficient to test at a temperature in the range between -20 °C and $+120\text{ °C}$, as the mechanical properties, according to the standard, do not change by more than 5% of the mean value of the property values on account of the temperature change.

All the testing methods assume that a pre-load of 10% is applied to cable support lengths and 50% to support elements, in order to allow settling. Then, the load is removed again and the deformations measured from this state.

All the samples on test are firstly subjected to the nominal safe working load (SWL) and, if the failure criteria are passed, then the load is increased to 1.7x the safe working load.

The first failure criterion is the approved deformation un-

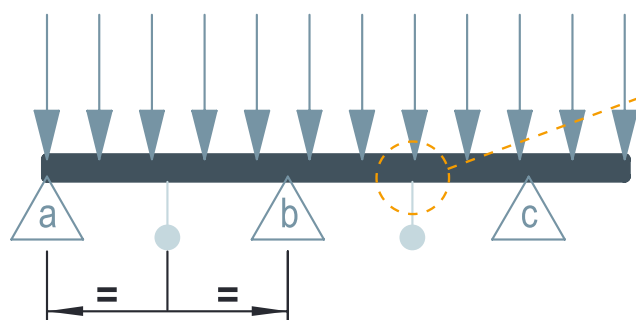

der the nominal safe working load. Here, the lateral bending of the cable support lengths and the fittings may not be greater than a maximum of $1/100$ of the support spacing and the transverse bending not greater than a maximum of $1/20$ of the nominal width (cable support lengths, fittings, support elements). In addition, for brackets, the transverse deformation is limited to a maximum of 30 mm under the SWL. Under the SWL, a support may bend by a maximum of $1/20$ of its length. Of course, the items on test and connections may not show any visible damage or breakages.

The lateral bending is measured in the middle of each field [ab] and [bc] as a calculated mean value of the left and right outer side (1 and 3) of a cable support. The transverse bending is determined at the same location as the difference between the mean value of the sensor in the middle (2) of the cable support base and the mean value of the lateral bending ($\varnothing 13$).

The second failure criterion is that the system may not collapse under an increased 1.7x load. However, strong deformation and bending are permitted under the increased load.

Special loads, such as the so-called human load, snow, rain, ice, wind, seismic activity or thermal tensions, are not tested with this method. According to the standard, snow, the wind load and other environmental risks are not considered to be the responsibility of the manufacturer. If necessary, the planner of the installation should take these influences into account.

This method basically checks the safe working load (SWL) of the cable support lengths and their connections, fittings and support elements.

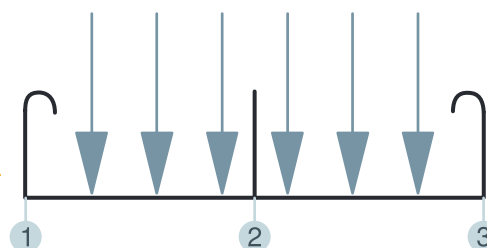

The tests for multi-field supports, mounted on the vertical plane with a horizontal direction of movement (typical application in power stations) and for rising sections, mounted in the vertical plane with a vertical direction of movement, are still being discussed in the currently valid version of the standard. The new draft standard plans a standardised test for this. OBO Bettermann can already present some load values according to this standard for the power station application.

For completeness, the so-called impact resistance according to IEC 60068-2-75 should be discussed at this point. Here, a hammer with a defined mass is struck against various items on test from a specified height, firstly on the base area or rung, and then dropped on each side section. After the test, the items on test may not show any signs of destruction or deformations which impede safety.



Impact energy [J]	Hammer mass [Kg]	Fall height [mm]
2	0.5	400
5	1.7	295
10	5.0	200
20	5.0	400
50	10.0	500

4.5.1 Cable support lengths as multi-field support

A multi-field support is considered to be a sequence of cable support elements (trays or ladders) and support elements erected for more than one field between the support points, i.e. it has multiple support points. This is the most common installation type of cable support systems.

Most cable support systems are mounted with their base in the horizontal plane and usually also run in a horizontal direction. For this installation type, the standard offers five different types of test, which are linked to certain conditions. This should ensure safe operation under all conditions.

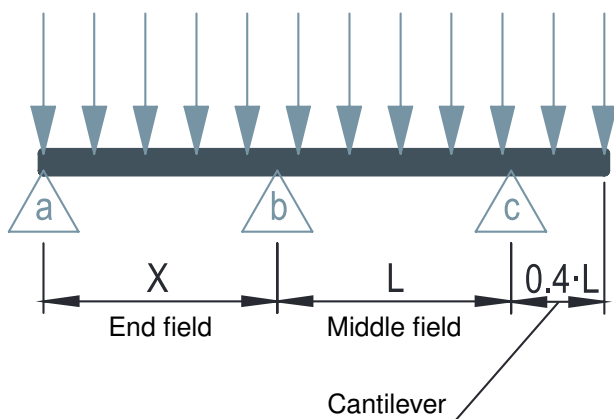

Test type	Conditions
I	<ul style="list-style-type: none"> No restriction for the customer as to where the connector can be mounted No limit to the end support width $X = L$ Connector is installed in the test in the middle of the end field between supports a and b
II	<ul style="list-style-type: none"> No connector permitted in the end support widths (end field) Manufacturer can reduce the end support width. $X \leq L$ (normally $X = 0.8 \cdot L$) Connector installed in the test in the middle of the middle field between supports b and c
III	<ul style="list-style-type: none"> Cable support length is equal to L or a multiple of the support width L If the cable support length is $1.5x$ the support spacing and the connector is positioned within 25% of the support spacing of the end field support Position of the connector in the end field is specified by the manufacturer End support width can be reduced by the manufacturer $X \leq L$ In the test, the connector is installed in each field between supports a, b and c
IV	<ul style="list-style-type: none"> Products with local weak points Weak point is arranged directly on the support Conditions for the test as I or II, with the smallest deviation, so that the weak point is installed directly over the support b
V	<ul style="list-style-type: none"> Testing of multiple support widths, if $L > 4 \text{ m}$ (wide span applications)

4.5.2 Cable support lengths as single-field support

If a cable support system section consists of cable support lengths and exactly two support points arranged at each end of the section, then this is termed a single-field support. In other words, it has a single support spacing. This may be the case when crossing corridors or, in hall construction, when crossing from one support pillar to another, if the cable support system does not continue across multiple field, i.e. the system ends at each support. This distinction from the multi-field support is important as the load on the system changes every metre at the same cable load.

Single-field supports in the horizontal plane are primarily mounted with a horizontal direction of movement. During the test, the connector must be located in the centre of the field, if not otherwise restricted by the manufacturer.

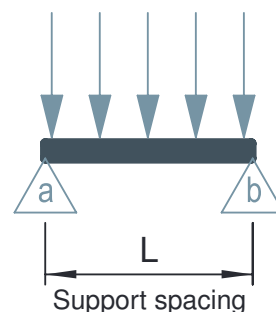

4.5.3 Fittings

For fittings (bend, T piece, cross-over), mounted with the base in the horizontal plane with a horizontal system direction of movement, the standard also prescribes a test if the fitting itself is not supported by a mounting element. The distance Y to the next support is stated by the manufacturer.

4.5.4 Brackets

Brackets are tested for use on the wall or support (a). The load is applied at two points, if the bracket is designed for cable trays and cable ladders (b). If the bracket is only constructed for cable trays, then the load is applied evenly at multiple locations (c). This reduces the stress on the bracket, allowing increased safe working loads. At OBO Bettermann, we generally test for the worse case. This ensures that the safe working load is always achieved.

4.5.5 Supports

The so-called suspended supports are subjected to no less than three tests.

Testing of the bend torque of supports on ceiling plates (a), ideally with 0.8 m support length. The safe working load is stated as $M1$ in Nm or kNm.

Testing of the tensile strength of supports or the head plate (b) as SWL data as F in N or kN.

Testing of the bend torque of supports with brackets (c), given as $M2$ in Nm or kNm. This test must be carried out on lengths $L = 0.5$ m, 1.0 m and 1.5 m, assuming that the items are available in the product range. Here, the supports are tested in combination with the mounted strongest and largest bracket recommended for the support.

A smaller role is played by the tests for a central (symmetrically) fastened bracket (d) and for supports with brackets/ceiling suspension (e) fastened at the ends. The latter is given the colloquial name of a monkey swing. Here, two threaded rods are used either as elements being pulled or as suspended supports with a horizontal stiff profile as a tray base.

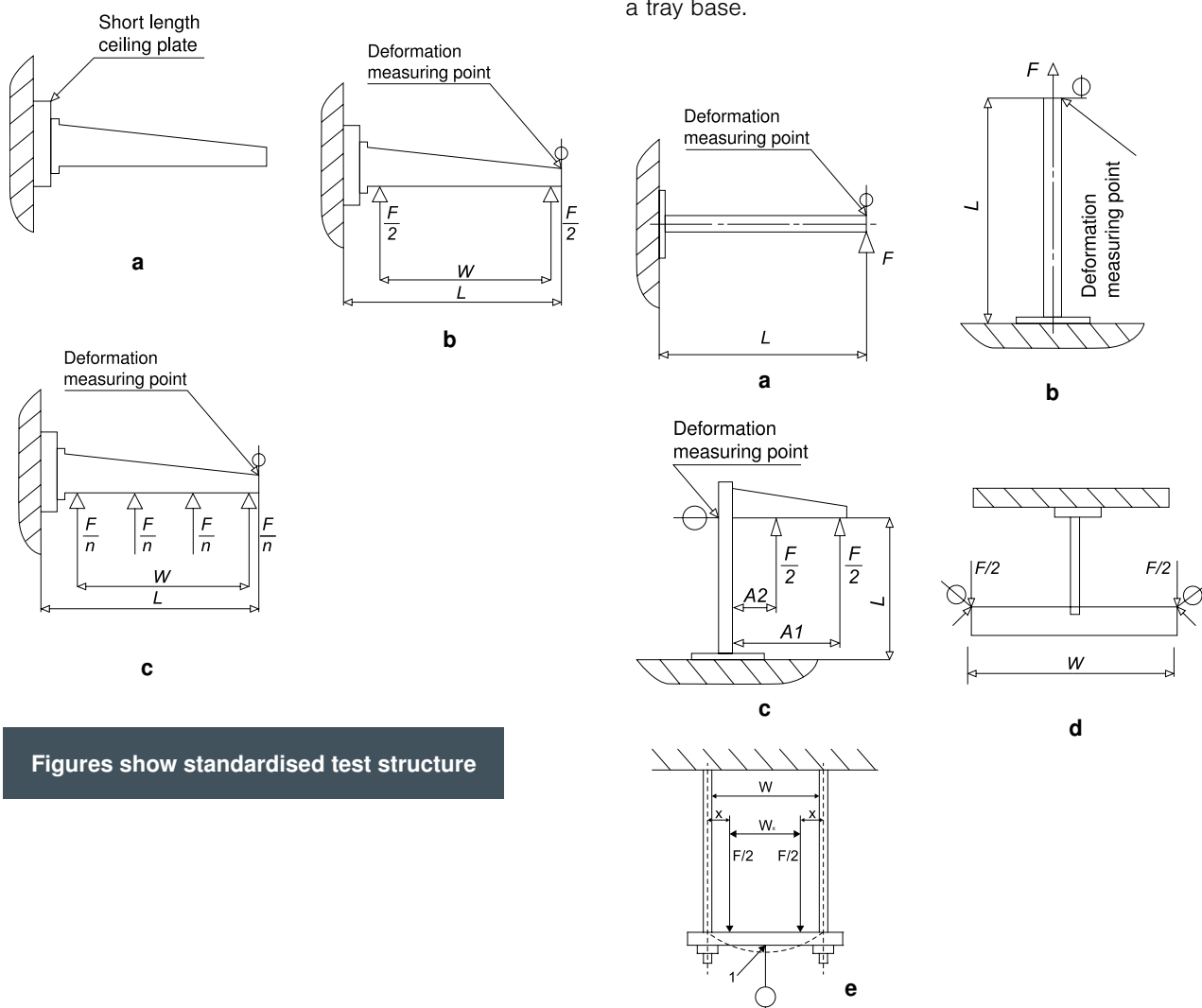

Figures show standardised test structure

4.6 Safe installation of supports with brackets

The installation of a suspended support with bracket is considered as safe when the following conditions are fulfilled.

1. The load applied to each bracket is less than the safe working load specified for the individual bracket (10.8.1).
2. The bending torque of supports with brackets M_2 is less than the safe working load for the support lengths used (10.8.2.3). An interpolation between the test results of various lengths is permitted.
3. The resulting bending torque on the ceiling plate M_1 and the resulting force F are within the safe area.

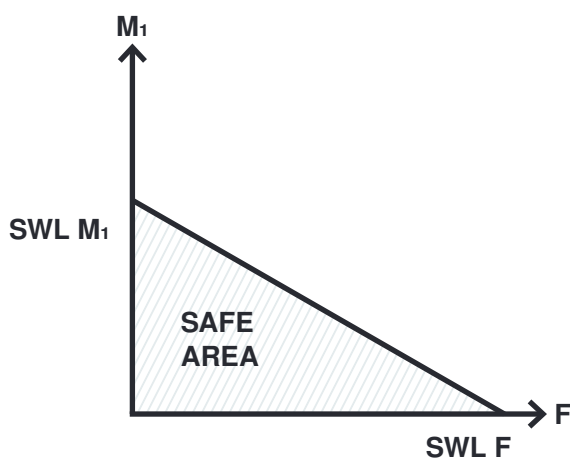
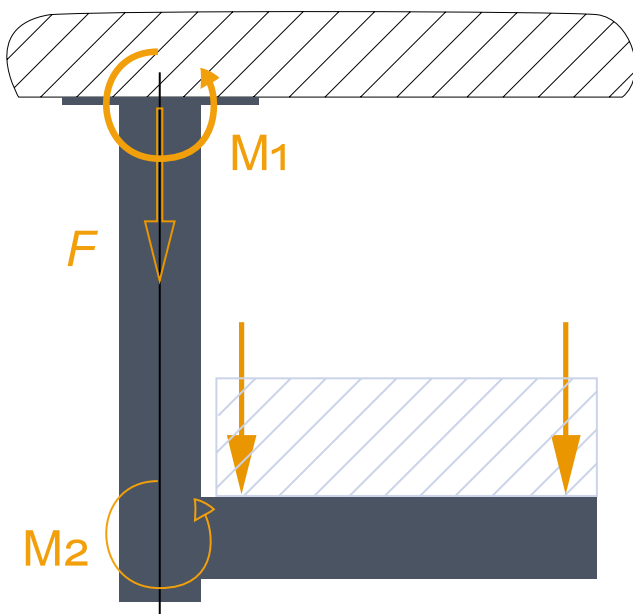

4.6.1 Electrical tests

In normal use, the products of the standard are passive with regard to electromagnetic influences (transmission and immunity). For this reason, the subject of EMC is not a part of the standard but often a topic in practice, which is dealt with in another section of this publication. If cable support systems are installed as part of a cabling installation, then the installation can transmit electromagnetic signals or be influenced by them. The level of influence is dependent on the nature of the installation in its operating environment and on the devices connected to the cabling.

According to IEC 61537, the electrical conduction properties or the electrical insulation properties are tested. This is dependent upon how the system was classified.

Cable support systems, classified according to 6.3.2 as "with electrical conduction properties", must have a sufficient electrical conductivity, in order to ensure the equipotential bonding and connection(s) with the earth, if this is required according to the application of the cable support system. Here, the system, consisting of two cable support lengths and the system-dependent connector, is subjected to an alternating current of 25 A at an idle voltage of less than or equal to 12 V (AC 50–60 Hz). A first voltage drop is measured over a section of 50 mm on each side of the connector. The resulting impedance (transition resistance) may not exceed 50 m Ω . Various connectors must (if available) be tested separately. A second voltage drop is measured over a section of 500 mm without a connection point. The resulting impedance may not exceed 5 m Ω /m.

Cable support systems, classified according to 6.4.2 as an "electrically non-conductive system component", shall be considered as non-conductive if the specific surface

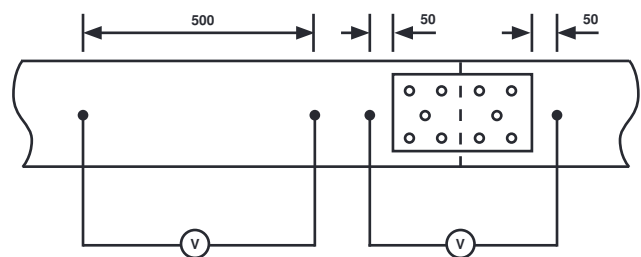

resistance is greater than 100 m Ω . Metallic cable support systems with a coating are always considered as conductive.

4.6.2 Fire risks

A cable support system cannot generally represent the cause of a fire, only contribute to it. Regarding the design of cable support systems, the standard prescribes that non-metallic mixed materials, which may be subjected to exceptional heat due to electrical errors, must be non-flammable. For this, the glow wire test according to IEC 60695-2-11:2000 Section 4-10 is carried out with a glow wire temperature of 650 °C. System components which do not spread flames may either not ignite or have a limited spread of flames.

5. Declarations

5.1 Certifications	35
5.2 VDE symbol approval	35
5.3 UL certificate	35
5.4 Underwriters Laboratories (UL) and Canadian Standards Association (CSA Group)	35
5.5 EPD Environmental Product Declaration	36
5.6 Maintenance of electrical function for safety-relevant electrical systems	36
5.7 Cable systems with integrated maintenance of electrical function	37
5.8 DIN 4102 Part 12: Contents and requirements	37
5.9 VDE 0100 Earthing: Definition, legal and standard requirements	37
5.10 International standardisation	38
5.11 EC declarations of conformity	39

5.1 Certifications

For OBO, product quality is closely connected to continuous testing and checking – which is why we manufacture almost all our products ourselves. This enormous depth of production is an expression of our demand for quality. From construction and the raw materials used, through production up to logistics, our employees vouch personally for the quality and availability of the OBO products. The multitude of approvals emphasises our high demand for quality and product functionality. Besides our integrated quality management, which forms the basis of our ISO 9001 certification, has existed since 1994 and stands for clear, lived processes, we possess further product-specific certificates, depending on the product and area of requirements. These guarantee that the appropriate products correspond to the national or normal standards and are issued by independent certification institutes. In addition, there are annual audits, depending on the certificate and institute, in order to test the current manufacturing processes. The key certificates in the field of cable support systems are described in more detail below.



5.2 VDE symbol approval

VDE is the Association for Electrical, Electronic and Information Technologies, their study and the technologies and applications

based upon them. The **VDE symbol** for electrical products marks conformity with the VDE conditions or European or internationally-harmonised standards and confirms compliance with the safety requirements of the appropriate directives. The VDE symbol stands for the safety of the product with regard to electrical, mechanical, thermal, toxic, radiological and other risks.

The VDE test mark guarantees that, for example, our RKSM cable tray has been tested correctly according to the underlying standards.



5.3 UL certificate

Underwriters Laboratories (UL) is an independent organisation that tests and certifies product safety. The **UL test mark** represents the proven conformity of a product with

the safety requirements of the USA and Canada. However, the UL test mark is also one of the most well-known symbols of quality around the world and is considered reliable proof of the safety of the product used.

Depending on the product and application area, UL offers various certifications with the appropriate test marks. The most commonly used test marks are the test mark "UL Listed", the test mark "Recognised Component" and the "UL Classification Symbol".

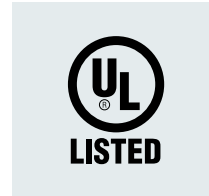

The **UL Listed test mark** represents proof of the testing and agreement of a representative product sample with regards to the safety requirements valid at UL.

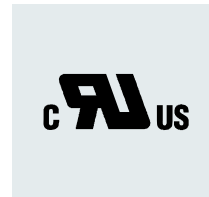

The **Recognised Component test mark** is more commonly used for components of a system, such as switches or power supply units.



The decisive test mark for the field of cable support systems is the **UL Classification Symbol**, which certifies the testing and evaluation of certain properties of the products. Here, performance criteria and testing methods of the NEMA (National Electrical Manufacturers Association), a standardisation organisation in the USA, are used, in order to test and confirm the suitability of the products under certain conditions.

and confirm the suitability of the products under certain conditions.

5.4 Underwriters Laboratories (UL) and Canadian Standards Association (CSA Group)

Besides the independent UL organisation, the CSA Group represents another major independent organisation, which is located in Canada. Both UL test marks and CSA test marks on products confirm that a representative number of products was certified according to a specific standard. As both organisations usually refer to the same standards, the CSA and UL organisations have signed a Memorandum of Understanding, in order to simplify the certification process for companies. In turn, this means that tests, inspections and certificates according to the North American Standard are mutually recognised. Both CSA and UL approvals can be applied for in the same way. The following overview summarises the target markets and the appropriate test marks.

		Target market		
		USA	Canada	USA & Canada
Certification office	UL	 This test mark is used by the American testing office for the US market.	 Test mark for the Canadian market (c on the left-hand side of the logo)	 Test mark of the American testing office for the US and Canadian market
	CSA	 This test mark is used by the Canadian testing office for the US market.	 Test mark for the Canadian market, issued by the Canadian testing office	 Test mark of the Canadian testing office for the US and Canadian market

5.5 EPD Environmental Product Declaration



The requirements for sustainable production processes and the demand for environmental declarations by architects and planners continue to increase, as they frequently serve as the decision-making basis for the optimum combination of construction products.

An environmental product declaration differs from certificates like the UL certification, because, here, the data of the company and the products is not evaluated, but simply summarised according to the standards described below. The basis for an EPD is the international standards ISO 14025 and EN 15804, which, on the one hand, regulate the basic principles and methods for the type III environmental labelling and, on the other, define the appropriate product category, according to the construction product. Eco-balances are used to compile EPDs and are created according to DIN EN ISO 14040 and 14044.

EPDs not only allow the eco-balancing and evaluation of buildings, but also integral planning. Even in the drafting phase, architects and technical planners use EPDs to compare various components, construction methods and variants and can thus select the ideal combination of construction products for each individual building.

Thanks to EPDs for materials, construction products and components, it is now possible to include ecological aspects in the sustainability evaluation of structures. The emphasis is primarily on the basic information for the evaluation of ecological building quality. The comprehensive and detailed eco-balance data and information contained in the EPDs are summarised in a standardised format over

just a few pages. Here, the phases of manufacture and disposal are taken into account in a life-cycle analysis.

In addition, our EPDs are published by Deutsche Gesellschaft für Nachhaltiges Bauen (DGNB) and, in this context, carry the DGNB label. This means that the internationally-recognised EPDs form a key cornerstone of the building certification systems of DGNB, BNB, BREEAM and LEED.

5.6 Maintenance of electrical function for safety-relevant electrical systems

If there is a fire, key technical equipment, such as emergency lighting, fire alarm systems or smoke extraction systems, must continue to function. In addition, certain technical systems must support the fire brigades in fighting fires for a sufficiently long period of time. To guarantee the power support and thus the maintenance of electrical function for these electrical systems during a fire, the appropriate installations must be created with special cables and routing systems.

Technical equipment that maintains the electrical functionality is required for the following buildings and areas: hospitals, hotels, restaurants, tower blocks, meeting places, shops, closed indoor car parks, metro systems, the chemical industry, power stations and tunnels. These buildings are frequently visited by large numbers of people, creating an increased safety risk for gatherings of people. However, with certain systems, property and the environment must also be protected.

The requirement for electrical installations that maintain the electrical functionality is a component part of the construction regulations. Here, the maintenance of electrical function relates solely to the areas connected to the power supply of safety-relevant electrical systems. Besides the items listed above, these also include, for example, alarm systems or automatic extinguishing systems. Here, the regulations require that the power supply must be guaranteed for a specific period of time, even if there is a fire.

5.7 Cable systems with integrated maintenance of electrical function

A cable system with integrated maintenance of electrical function according to **DIN 4102 Part 12** is considered as the routing system (cable ladders, cable tray, clips, etc.) in combination with cables. The proof of the maintenance of electrical function must be provided by a fire test at an independent material testing institute. Depending on the function length passed, the cable system receives the classifications **E30**, **E60** or **E90**. This is documented in a testing certificate.

There is currently no European standard on the maintenance of electrical functionality, but there are some national test regulations, e.g. according to PAVUS in the Czech Republic. The most widely spread and accepted is the testing according to DIN 4102 Part 12. Work is currently being carried out on the European standards.





5.8 DIN 4102 Part 12: Contents and requirements

DIN 4102 Part 12 defines standard routing systems with appropriate mounting parameters. In addition, there are so-called cable-specific routing types, which allow more economic applications, e.g. by increasing the fastening distances or higher approved cable loads.

The tests according to DIN 4102 Part 12 are supplementary tests, in addition to the requirements from the standards of the electrical and mechanical applications.

Refer to the OBO fire protection guide for further information.

5.9 VDE 0100 Earthing: Definition, legal and standard requirements

For their approval, cable support systems must correspond to the standard DIN EN 61537 "Cable management - Cable tray systems and cable ladder systems". A component part of DIN EN 61537 is also the proof of continuous electrical conductivity, required by Point 11 - Electrical properties.

Whether or not a support system must be included in the equipotential bonding is specified at another point. According to the generally valid requirements in DIN VDE 0100, a cable support system need not be included in the equipotential bonding, as cables are usually routed there which, besides their jacketing, also possess wire insulation. As, according to the VDE, there are no double errors, the standard considers that the double insulation excludes the possibility of the support system being energised if there is an error.

However, if the support system is defined as a foreign conductive part in the hand area according to DIN VDE 0100 Part 410, then it must be included in the equipotential bonding. Metallic cable routing ducts or device installation ducts or rising sections would be typical examples of this.

If cabling for information technology is (also) routed on or in the cable support systems, then the support systems must always be included in the equipotential bonding.

Then, DIN EN 50174-2 "Information technology - Cabling installation - Part 2: Installation planning and practices inside buildings" applies. Accordingly, the support system must be included in the equipotential bonding according to Point 5.3.3.2 "Electrically conductive cable routing systems" and 5.3.3.3 "Electromagnetic shielding".

To be on the safe side, and in case of error, to guarantee safe switch-off of the error currents, OBO always recommends including support systems for cable routing in the equipotential bonding.

5.10 International standardisation

International standardisation in the field of electrical engineering is brought together by the IEC (International Electrotechnical Commission) as the organisation for the introduction of international standards. A total of 173 countries are represented in this commission, who are working to unify standards.

In turn, these countries possess national committees and commissions to represent their national interests. As an example, for Germany, DKE (Deutsche Kommission Elektrotechnik Elektronik Informationstechnik) is the responsible organisation for the compilation of standards. This organisation is a member in the IEC and the CENELEC (European Committee for Electrotechnical Standardisation).

Each member state possesses a national commission and sends experts into the different committees for the creation of the international standards.

However, these national commissions can specify deviations for the valid national standard, on the basis of the international standard. This means that there may be requirements that deviate from an IEC standard.

For this, there are certain rules that the national committee must comply with. An important aspect is that the deviations may only represent a tightening of the currently valid IEC standard. A softening or reduction of the requirements is not permitted.

Here are some examples of national committees:

Germany – Deutsche Kommission Elektrotechnik Elektronik Informationstechnik (DKE)

France – Union Technique de l'Electricité (UTE)







United Kingdom – British Standard Institution (BSI)

Russia – Federal Agency for Technical Regulation and Metrology (GOST)

USA – American National Standards Institute (ANSI)

A special feature of national standardisation in the USA is the coming together of manufacturers and producers, represented as a subcommittee in NEMA (National Electrical Manufacturers Association). This should be regarded in a similar light to DKE in Germany.

The following image shows the interconnections in a simplified manner.

	General information	Electrical engineering	Telecommunications
International			
Regional level (e.g. Europe)			
National level (e.g. Germany)			

5.11 EC declarations of conformity

The declaration of conformity is a written confirmation from a conformity evaluation, using which the person or office responsible for a product, the provision of a service or an organisation provides a binding declaration and confirmation that the object possesses the properties specified on the declaration.

There are no restrictions to the object of a declaration of conformity. This means that it is possible to declare the conformity of products, processes, people, jobs or management systems.

The CE marking is the result of an EC declaration of conformity and a conformity mark, which states that a product agrees with the harmonisation regulations of the European Union. It is the visible consequence of the overall process of conformity evaluation and the resulting declaration of conformity.

The CE label is thus a "figurative mark" and does not represent an abbreviation.

The CE symbol is always applied by the manufacturer and is done in a clearly visible, legible and permanent location on the product or the product type plate. If this is not possible, it can also be attached to the packaging or the accompanying documents.

To compile a declaration of conformity and the resulting CE labelling, some things must be observed which must always be complied with. The **"responsible manufacturer"** or their representative located in the EU provides confirmation, at their own responsibility, of the legality.

- A declaration of conformity can only be compiled with a directive of the European Parliament and Council.
- The harmonisation of the legal requirements of the member states for free market access is described in the directives.
- The basis of the conformity evaluation, as well as the compilation of the declaration, is the harmonised standards assigned to the appropriate directive.
- Products and other services to be assigned to a standard and which are not harmonised with a directive may not be certified with conformity. These products must be certified with a manufacturer's declaration, stating the applicable standard.

The required contents of the EU declaration of conformity is specified in the individual EU directives. By contrast, no requirements in relation to the form and appearance are stated. General requirements in relation to the contents of the declarations of conformity and also design suggestions are contained in the standards EN ISO 17050-1 and EN ISO/IEC 17050-2, as well as in the Blue Guide of the European Commission.

6. EMC/shield attenuation

6.1 General information	41
6.2 Magnetic shield insulation	42
6.3 Summary	43

6.1 General information

It may occur that cables have to be routed in areas with electromagnetic interference fields.

Sources of such electromagnetic interference fields can be, for example, electrical resources (motors) starting up, inverters, switching operations in electrical systems or lightning currents.

These interference fields can cause fault voltages and currents in cables, depending on their intensity, frequency and distance (Figure 1, left), which impede the function of the connected resources, or even destroy them.

With their high current values of over 200,000 amps and fast ramps of less than $0.25 \mu\text{s}$ (corresponding to a frequency of 1,000 kHz), lightning currents represent the strongest interference fields, which alternate rapidly.

The electromagnetic interference field generally consists of two different fields: The electrical field and the magnetic field. The different fields require different measures as protection against their damaging impact.

As protection against interference from the electrical field, a partition of conductive material is required, which is to

be included in the equipotential bonding, and thus must be earthed. Depending on the frequency of the electrical interference field, mesh partitions are sufficient.

As protection against interference from the magnetic field, shielding completely closed on all sides with conductive material – is required. In this shielding, an alternating magnetic field generates Foucault currents, which act against their cause (law of induction), thus creating an interference-free area within the shielding. Electrically non-conductive areas in the shielding, such as slits and openings, interrupt the Foucault currents, thus reducing the magnetic shield impact.

Closed, metallic cable support systems, which are included in the equipotential bonding, such as cable trays, thus offer optimum protection of cables in areas with electromagnetic interference fields (Figure 1, right).

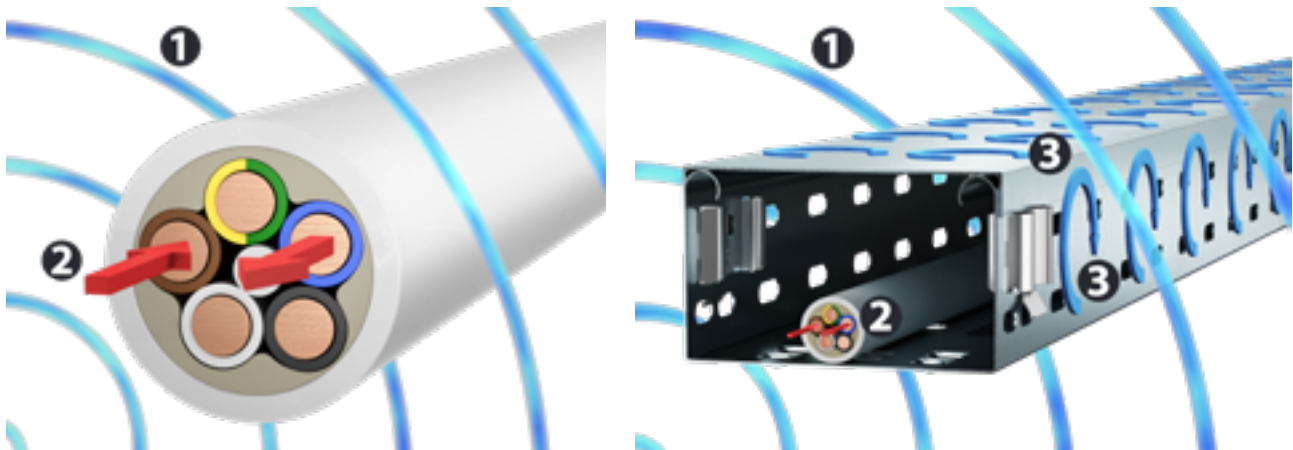

- ❶ Interference field
- ❷ Induced interference current
- ❸ Foucault currents

6.2 Magnetic shield insulation

DIN CLC/TR 50659:2020-08 (VDE 0604-2-200) describes a testing procedure to measure the magnetic shield attenuation of cable support systems.

A U-shaped antenna is used, through which a lightning current flows with a ramp of approx. 8 µs, creating a magnetic field of interference. In this arrangement, there is a closed conductor loop of two parallel cables in the centre.

The magnetic interference field generates an interference current in the conductor loop (induction law). The basic arrangement of the test structure is shown in Figure 2.

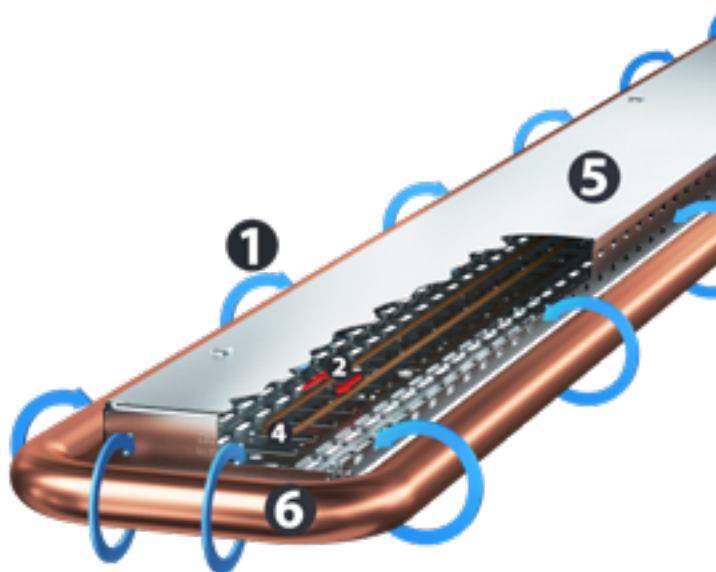

- ❶ Interference field
- ❷ Induced interference current
- ❸ Foucault currents
- ❹ Conductor loop
- ❺ Cable support system
- ❻ U-shaped antenna

The magnetic shield attenuation (SE) is 20x the decadic logarithm from the ratio of the interference signal occurring without protective measures (I_{ref}) to the interference signal occurring with the protective measure (cable support systems) (I_{sample}) and is calculated as follows and stated in dB.

$$SE (dB) = 20 \times \log \left(\frac{I_{ref}}{I_{sample}} \right)$$

With a stated magnetic shield attenuation (SE) of 20 dB, this means that this protective measure (cable support systems) reduces the interference current in cables by 90%. 40 dB means a reduction of 99%.

6.3 Summary

Closed, metallic cable routing systems included in the equipotential bonding reduce the interference currents and interference voltages induced in a cable through an electromagnetic interference field, compared to routing without or in non-metallic cable routing systems. Here, closed, metallic cable routing systems offer the highest magnetic shield attenuation.

Perforated cable routing systems also offer a high magnetic shield attenuation, which, however, decreases with an increasing hole size.

Therefore, mesh cable trays and cable ladders only offer low magnetic shield attenuation. If open cable routing systems (without covers) are used, the magnetic shield attenuation decreases accordingly.

The table provides an overview of the magnetic shield attenuation of various versions of cable routing systems.

Version of the cable routing system	Closed (With cover)	Open (Without cover)
Without perforation/holes	40 dB (99%)	25 dB (94%)
15% perforation/holes	30 dB (97%)	20 dB (90%)
28% perforation/holes	25 dB (94%)	15 dB (82%)
Cable ladders	18 dB (87%)	11 dB (72%)
Mesh cable tray	14 dB (80%)	7 dB (55%)

Magnetic shield attenuation of various cable support systems (reduction of the interference current by %)

7. Our support for your project

7.1 OBO Academy – from basic principles to the concrete application	45
7.2 OBO Construct – planning software and product configurators	46
7.3 OBO Customer Service	47

OBO Academy

OBO Academy – from basic principles to the concrete application

For many years, the OBO Academy has offered a comprehensive portfolio of seminars. "Advantage through knowledge" is not just a slogan here, but a promise: With first-hand information, a link to practical situations and expert knowledge, we can offer participants a decisive knowledge advantage. In our seminars, planner days or online seminars, we will bring you up to speed with current developments, trends, standards and regulations.

No matter whether seminars, planner days, online seminars or individual consultation – the training offers of the OBO Academy are complete, orientated to the future and always aligned to the requirements of the participants.

Current dates, all the seminars and the possibility of online registration at www.obo-bettermann.com



OBO ACADEMY
Connect to knowledge



OBO Construct

Planning software and product configurators

Use OBO Construct to plan electrical installations more quickly and simply than ever before: OBO Construct is a collection of powerful planning tools, which was developed especially for electrical installation engineers and planners. OBO Construct offers support in product configuration and a selection aid for the matching systems, and automatically generates a corresponding parts list.

To make the software as user-friendly as possible, it is continually adapted further and its functionality optimised.



The advantages of OBO Construct:

- Time and location-independent, can be started from any terminal
- Matching products are found quickly and simply
- Automatic volume calculation
- Create project: Simply create projects for configurations and create building and use units for even more detailed planning
- Simply save the planning and edit it at a later time
- Documents, such as declarations of conformity, data sheets or detailed material lists, can be personalised with your own data

Learn more at
www.obo-construct.de

Currently available versions:

- KTS AutoCAD plug-in Version 3.0 (AutoCAD full version from 2013)
- KTS cable filling Version 3.0 (Windows PC application)
- UFS planning tool Version 3.0 (Web app for all devices)
- TBS earthing systems Version 1.0 (Web app for all devices)
- BSS insulation selection aid Version 2.5 (web application, iOS and Android app)
- TBS surge protection Version 1.0 (web application)



OBO support & contact

You can contact our Customer Service department on:

+49 (0)2373 89-17 00

Monday–Thursday
07.30–17.00

Friday
07.30–15.00

info@obo.de



Training



Service



Handling



Certification

Training courses from OBO

- Seminars and workshops
- Local consultation and training courses
- Planner days
- Webinars

Service – OBO can help you

Everywhere and in every project phase:

- Competent hotline
- Product and system information, digital or printed
- Selection and planning aids on the web, as an app, as a CAD application or in printed form
- 2D and 3D product data for planning
- Field service, branch offices and subsidiary companies in 60 countries
- Engineering services for major projects

Handling – OBO delivers reliably

With optimised delivery processes:

- Reliable logistics
- Practical transport systems and packaging
- Loading gear handling and disposal concepts

Certification and guarantee

OBO offers safety. Our products fulfil the most important country-specific regulations:

- Conformity (e.g. IEC, VDE, CE, KEMA, KEUR, UL)
- Certification (e.g. DIN EN, DGNB)
- 5-year guarantee for surge protection products
- Guarantee management

OBO Bettermann Holding GmbH & Co. KG

P.O.Box 1120
58694 Menden
GERMANY

Customer Service Germany

Tel.: +49 (0)23 73 89 - 17 00
Fax: +49 (0)23 73 89 - 12 38
export@obo.de

www.obo-bettermann.com

© OBO Bettermann Order no. 9163191 04/2023 EN

Building Connections

